

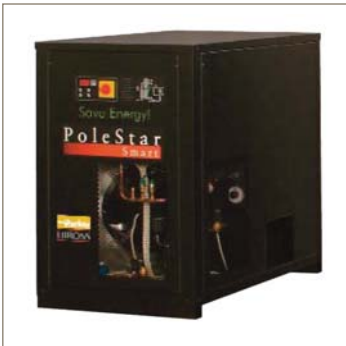

aerospace
climate control
electromechanical
filtration
fluid & gas handling
hydraulics
pneumatics
process control
sealing & shielding



Parker Filtration

Compressed Air & Industrial Gas Catalogue



ENGINEERING YOUR SUCCESS.

Parker Filtration

Meeting your product and sales training needs

Our world-wide reputation in providing quality product and sales training courses has been acknowledged as a great success.

domnick hunter offers a variety of training courses which improve product knowledge and increase sales performance.

All domnick hunter trainers are specialists in their subjects, which means that delegates quickly grasp new ideas, and leave the training courses with the confidence and motivation for continued business success.



AUSTRALIA	Telephone:	+ 612 9842 5882/9842 5860
	Fax:	+ 612 9842 5862
	E-mail:	dh.Australia@parker.com
NEW ZEALAND	Telephone:	+ 649 574 1744
	Fax:	+ 649 573 1529
	E-mail:	rbibikar@parker.com

Customer Service - Our aim to please

**A guide to where to get help and advice.
If in doubt, please ask for Customer Services
who will be pleased to assist you.**

For Price and Availability

If you know the description and/or part number of the item(s) you require - please contact Customer Services. Telephone +612 9842 5882 / 9842 5860. If you require assistance then please refer to the undernoted advice.

Placing an Order

Please fax all orders directly to Customer Services. Fax +612 9842 5826. We will ensure that your order is checked and delivered as required. Kindly provide a contact name and telephone number on all orders in case any queries arise.

For Product Advice, Selection and Technical Support.

If you require assistance in selecting the best solution for your system - please contact your domnick hunter sales representative.

For Service and Warranty

If you require advice on any parts you require to service a domnick hunter PNEUDRI dryer(s), Breathing Air equipment or for information about warranty or service contracts, please ask for our Service Department.

For Status of an Existing Order

If you wish to know the shipment date or despatch details of an existing order, please contact Customer Services.

Any Queries Regarding Payment

Please call our Credit Control personnel who will assist you with any questions regarding settlement of invoices and accounts. **Call (02) 9634 7777**

Dissatisfaction

If you have a complaint or wish to return any goods to domnick hunter, please call Customer Services who will be pleased to assist you. domnick hunter wishes to ensure that its customers are more than satisfied with its products and services and always welcomes feedback.

Parker Filtration

Phone +612 9842 5882/9842 5860 - **Fax** +612 9842 5862

E-mail - dh.Australia@parker.com

Web page www.parker.com www.domnickhunter.com

Price list notes

1. Prices shown are ex-works Melbourne and are subject to change without notice.
Express deliveries can be arranged if required. Please contact Parker Filtration for further details.
Prices are in AUD and do not include GST.
2. Product lead times are given for general information and guidance only. Many factors can influence lead times which will be quoted specifically upon request. No warranty is given or implied.
3. Conditions of sale will be strictly in accordance with our Terms and Conditions.
4. Parker Filtration, a division of Parker Hannifin Ltd has an on-going policy of product development and although the Company reserves the right to change specifications it attempts to keep customers informed of any alterations. This publication is for information only and customers are requested to ask our Technical Services Department for advice on a product's suitability for specific applications.
5. Please refer to Parker's standard terms and conditions on the following page.

APPROVALS, ACCREDITATIONS AND ASSOCIATIONS



ISO 9001:2000 ISO 14001



INTERNATIONAL APPROVALS



ASME VIII

CRN



Lloyd's Register

AS1210



pneurop



Druckluft
effizient

Standard terms of sale

Sole Terms

1. These conditions of sale apply to all transactions between the Buyer and the Seller, including all quotations, offers, acknowledgements, orders or sales.
2. These conditions (which will only be waived or varied in writing signed by the Seller) will prevail over all conditions of the transaction to the extent of any inconsistency. Acceptance of the Sellers product shall constitute acceptance of these terms and conditions of sale.

Delivery

3. While the Seller endeavours to keep delivery dates, any delay of delivery, for any reason whatsoever, will not entitle the Buyer to claim for any consequential loss or damage or to cancel, rescind or terminate the agreement.
4. Should circumstances beyond the control of the Seller prevent or hinder delivery, the Seller will be free from any obligation to deliver goods while such circumstances continue. For as long as such circumstances exist, the Seller may, at its option, cancel, rescind or terminate all or any part of the contract or keep the contract on foot until such circumstances have ceased. Such circumstances beyond the control of the seller include, but are not limited to: strikes, lockouts, rebellions; fire; acts of God; shortages of raw materials; Government decrees, proclamations or orders; transport difficulties; and failures or malfunctions of computers or other information technology systems.

Instalment Deliveries

5. Deliveries by instalments must be requested by the Buyer within the times stipulated in the contract.
6. Where the Buyer fails to request or accept instalment deliveries in accordance with the terms of the contract:
 - a) the Seller may store the goods at the risk and cost of the Buyer; and
 - b) the Buyer will be deemed to be in default of payment for the delivery.
7. Where goods are ordered for delivery by instalments, each instalment delivery is deemed to be a separate order and a separate contract performed by the Seller upon delivery of that instalment.

Risk

8. Risk in each order will pass to the Buyer when it is delivered to the carrier at the supplier's premises for the purpose of transmission to its destination but the property in the consignment does not pass other than in accordance with clause 11 of these terms of sale.
9. Subject to clause 8, where, in accordance with these terms, the Seller accepts return of any goods, risk in those goods will revert to the Seller upon delivery of the goods to the Seller or upon collection of the goods by the Seller's agent or courier as the case may be.
10. Any property of the Buyer's under the Seller's custody or control will be entirely at the Buyer's risk as regards loss or damage caused to the property or by it.

Retention of Title

11. Notwithstanding delivery of the goods to the Buyer, until the Buyer has effected full payment for the goods and any other goods previously supplied by the Seller:
 - a) legal title to the goods will remain with the Seller;
 - b) the risk in the goods will pass to the Buyer upon delivery to the Buyer or its agent;
 - c) the relationship between the Seller and the Buyer will be fiduciary and the Buyer will hold the goods as bailee for the Seller and keep them separate from other goods and the Buyer will label the goods so that they are identifiable as the goods of the Seller; and
 - d) in the event that the Buyer uses the goods/product in some manufacturing or construction process of its own or some third

party, then the Buyer will hold such part of the proceeds of such manufacturing or construction process as relates to the goods/product in trust for the Seller. Such part will be deemed to equal in dollar terms the amount owing by the Buyer to the Seller at the time of the receipt of such proceeds.

12. The Buyer is not an agent of the Seller in any sale by the Buyer of the goods.
13. If the goods are resold (save where products manufactured using the goods are sold), by the Buyer, the Buyer will hold such part of the proceeds of any such sale as represents the invoice price of the goods sold or used in the manufacture of the goods sold in a separate identifiable account as the beneficial property of the Seller and will pay such amount to the Seller upon request.
14. Notwithstanding the provisions above the Seller will be entitled to maintain an action against the Buyer for the purchase price.
15. Until title to the goods passes to the Buyer, the Buyer will store the goods in such a manner that clearly identifies them as being the property of the Seller.

Payment

16. The Buyer will pay the full price of each order to the Seller 30 days from the date of delivery of the item purchased (the due date). If payment is not made by the due date, the Seller may without demand retake possession of the goods and may without notice sell the goods on such terms and in such manner as it may determine and will be entitled to deduct all expenses incurred. For the purpose of recovering possession, and without limiting the generality of the foregoing the Buyer hereby irrevocably authorises and licenses the Seller and its servants and agents to enter upon any premises where any goods may be stored and to take possession of the goods.
17. If the seller is not paid for any goods on the due date specified in this agreement, without prejudice to any other right or remedy:
 - (a) all outstanding money carries interest on daily balances until paid at a rate of interest per annum equal to the rate 2% in excess of the interest rate charged by National Australia Bank Limited on overdraft accounts for sums up to \$50,000 Australian dollars; and
 - (b) the seller may recover the price of the goods together with all interest forthwith from the buyer as a liquidated debt in a court of tribunal of competent jurisdiction irrespective of any claim that the buyer may have against the seller for any thing or matter related to the goods delivered under this contract.
18. All applicable taxes, duties or levies (including GST) on the sale of the goods will be to the Buyer's account.
19. The Seller may, at its option and without prejudice to any of its rights, either suspend further deliveries, require payment in advance or terminate any contract by written notice to the Buyer where the Buyer:
 - (a) defaults on any payment due under the agreement;
 - (b) being a natural person, commits an act of bankruptcy;
 - (c) being a corporation, is subject to:
 - (i) a petition being presented, an order being made or a meeting being called to consider a resolution for the Buyer to be wound up, deregistered or dissolved;
 - (ii) a receiver, receiver and manager or an administrator being appointed to all or any part of the Buyer's property and undertaking.
 - (iii) the entering of a scheme of arrangement (other than for the purpose of restructuring); or
 - (iv) any assignment for the benefit of creditors.

Acceptance of Goods

20. The Buyer will inspect the goods immediately upon delivery to the Buyer or upon collection of that order by the Buyer's agent or courier as the case may be.
 21. All claims against the Seller regarding the quality, nature, fitness, suitability, conformance with description or defects of the goods must be made in writing to the Seller within 14 days of delivery.
-

The Seller does not accept liability for any such claim not made in accordance with these terms.

22. In the event of justified objection notified by the Buyer to the Seller in accordance with these terms, the Seller may, at its option:
- (a) reduce the purchase price by agreement with the Buyer;
 - (b) accept the return of the goods and, subject to the goods being returned in the same condition as when they were delivered to the Buyer, refund to the Buyer the purchase price; or
 - (c) replace the goods
- and no additional claims of any nature whatsoever may be made against the Seller.

Indemnity for Infringement of Intellectual Property Rights

23. Seller shall have no liability for infringement of any patents, trademarks, copyrights, trade secrets, or other industrial or intellectual property rights, passing off or misleading or deceptive conduct ("Intellectual Property Rights") except as provided in this clause 23. Seller will defend and indemnify Buyer against allegations of infringement of Intellectual Property Rights. Seller will defend at its expense and will pay the cost of any settlement or damages awarded in an action brought against Buyer based on an allegation that a good sold pursuant to this contract infringes the Intellectual Property Rights of a third party. Seller's obligation to defend and indemnify Buyer is contingent on Buyer notifying Seller within 10 days after Buyer becomes aware of such allegations of infringement, and Seller having sole control over the defence of any allegations or actions including all negotiations for settlement or compromise. If a good sold is subject to a claim that it infringes the Intellectual Property Rights of a third party, Seller may, at its sole expense and option, procure for Buyer the right to continue using the good, replace or modify the good so as to make it non-infringing, or offer to accept return of the good and return purchase price less a reasonable allowance for depreciation. Notwithstanding the foregoing, Seller shall have no liability for claims of infringement based on information provided by Buyer, or directed to goods delivered under this contract for which the designs are specified in whole or part by Buyer, or infringements resulting from the modification, combination or use in a system of any good sold. The foregoing provisions of this clause 23 shall constitute Seller's sole and exclusive liability and Buyer's sole and exclusive remedy for infringement of Intellectual Property Rights.

If a claim is based on information provided by Buyer or if the design for a good delivered is specified in whole or in part by Buyer, Buyer shall defend and indemnify Seller for all costs, expenses or judgments resulting from any claim that such item infringes any patent, trademark, copyright, trade dress, trade secret or any similar right.

Special Tooling

24. A tooling charge may be imposed for any special tooling, including without limitation, dies, fixtures, moulds and patterns, acquired to manufacture items sold pursuant to this contract. Such special tooling shall be and remain Seller's property notwithstanding payment of any charges by Buyer. In no event will Buyer acquire any interest in apparatus belonging to Seller which is utilized in the manufacture of the items sold, even if such apparatus has been specially converted or adapted for such manufacture and notwithstanding any charges paid by Buyer. Unless otherwise agreed, Seller shall have the right to alter, discard or otherwise dispose of any special tooling or other property in its sole discretion at any time.

Buyers Property

25. Any designs, tools, patterns, materials, drawings, confidential information or equipment furnished by Buyer, or any other items which become Buyer's property, may be considered obsolete and may be destroyed by Seller after two consecutive years have elapsed without Buyer placing an order for the items which are manufactured using such property. Seller shall not be responsible

for any loss or damage to such property while it is in Seller's possession or control.

Changes, Reschedules and Cancellations

26. Buyer may request to modify the designs or specifications for the goods sold as well as the quantities and delivery dates of the items, or may request to cancel all or part of this order, however, no such requested modification or cancellation shall become part of the contract between Buyer and Seller unless accepted by Seller in a written amendment to this document. Acceptance of any such requested modification or cancellation shall be at Seller's discretion, and shall be upon such terms as Seller may require.

Warranty

27. Seller warrants that the goods sold shall be free from defects in material or workmanship for a period of 12 months* from date of shipment from the seller. This warranty comprises the sole and entire warranty pertaining to goods provided. The seller makes no other warranty, guarantee, or representation of any kind whatsoever. All other warranties, including but not limited to merchantability and fitness for use, whether expressed, implied, or arising by operation of law, trade usage, or course of dealing are by this document disclaimed. Notwithstanding the foregoing, there are no warranties whatsoever on goods built or acquired wholly or partially, to buyer's designs or specifications. Nothing in this clause will operate to exclude, restrict or modify any condition, warranty, right or liability implied into this contract under the Trade Practices Act or otherwise by law.

Advice and Information

28. Any advice, recommendation, information, assistance or service given by the Seller in relation to goods sold or manufactured by the Seller or their use or application is given in good faith and is believed to be accurate, appropriate and reliable at the time it is given, but is provided without any warranty or accuracy, appropriateness or reliability and the Seller does not accept any liability or responsibility for any loss suffered from the Buyer's reliance on such advice, recommendation, information, assistance or service.

Exclusion of Liability

29. The terms in this agreement that exclude or limit the Seller's liability will apply only to the extent permitted by law. Provisions of statutes from time to time in force cannot be excluded, restricted or modified or can only be restricted or modified to a limited extent. This agreement must be read and construed subject to any such statutory provisions. If any such statutory provisions apply, then to the extent to which the Seller is entitled to do so, its liability under those statutory provisions will be limited at its option to:
- (a) the replacement of the goods or the supply of equivalent goods; or
 - (b) the repair of the goods; or
 - (c) the payment of the cost of replacing the goods or of acquiring equivalent goods; or
 - (d) the payment of the cost of having the goods repaired.

In no event shall the Seller be liable for any incidental, consequential or special damages of any kind or nature whatsoever, including but not limited to lost profits arising from or in any way connected with this agreement or goods sold, whether alleged to arise from breach of contract, express or implied warranty, or in tort, including without limitation, negligence, failure to warn or strict liability.

Governing Law

30. This document shall be governed in all respects by the laws in force in the State of New South Wales. The parties accept and submit to the non-exclusive jurisdiction of the courts of the State of New South Wales. No actions arising out of the sale of the goods or this document may be brought by either party more than three (3) years after the cause of action accrues.

*Extendable under certain terms for some products



domnick hunter

If you would like more information about these products and other ranges of Parker Filtration purification products please visit www.parker.com or contact your local Parker Filtration representative.



Air / Gas
Filters



Liquid
Filters



Food and Beverage
Hospitals,
Pharmaceutical



Process Cartridge
Housings



Skids / Systems



Disposable
Capsules



Turbosep



Integrity &
Breathing Air
Test Equipment



Mixed Gas
Dispense Systems



domnick hunter

Compressed Air and Gas Filtration, Purification and Separation Products

COMPRESSED AIR AND GAS FILTRATION



OIL-X EVOLUTION
ENERGY EFFICIENT



COMPRESSED AIR
FILTER ELEMENTS



STAINLESS STEEL
UP TO 2"



HIGH PRESSURE
6000 PSI



J SERIES
LPG AND CNG

AIR DRYERS



Membrane



SPL/PST Refrigerated
Air Dryers



MX Compressed Air
Desiccant Dryers



DTV Compressed Air
Twin-Tower Dryers



Laboratory Clean Dry Air

GAS GENERATORS



Industrial Nitrogen



Laboratory Hydrogen



Laboratory Nitrogen



Laboratory Zero Air

WATER CHILLERS



VACUUM PUMP FILTERS



MEDICAL VACUUM FILTERS



CONDENSATE DRAINS



OIL/WATER SEPARATORS



Index

Compressed air and gas filtration, purification and separation products

OIL-X EVOLUTION filters

	PAGE
ISO 8573.1 Air Quality – High quality compressed air from generation to application	1-8
OIL-X EVOLUTION – Water Separators	9
OIL-X EVOLUTION – Flow rates, weights and dimensions	10
OIL-X EVOLUTION – Grade AO high efficiency general purpose protection	11
OIL-X EVOLUTION – Grade AA high efficiency oil removal filtration	12
OIL-X EVOLUTION – Grade AR general purpose dust filtration	13
OIL-X EVOLUTION – Grade AAR high efficiency dust filtration	14
OIL-X EVOLUTION – Grade ACS oil vapour and odour removal	15
OIL-X EVOLUTION – Grade AC point of use oil vapour and odour removal	16
OIL-X EVOLUTION – Grade OVR high efficiency oil vapour removal	17
OIL-X EVOLUTION – Filter accessories	18
OIL-Xplus filter accessories	19
Genuine Parker Filtration replacement filter elements	20
Alternative compressed air filter elements	21-22
OIL-Xplus intermediate pressure filters	23
OIL-Xplus stainless steel compressed air filters	24
Food grade compressed air	25-28
High flow TETPOR food and beverage sterile air filtration	29

Condensate products

ES2000 Series oil/water separators	30
Oil/Water Separator maintenance kits	31
ED 3000 Series Level Sensing Condensate Drains	32
HIROSS Aftercoolers	33

Compressed air dryers

SPL and PST Refrigeration dryers	34-35
PNEUDRI MiDAS point of use desiccant dryers	36
PNEUDRI MIDlplus compressed air desiccant dryers	37
PNEUDRI MX heatless compressed air desiccant dryers	38-39
PNEUDRI Maxi heat regenerative compressed air desiccant dryers	40-41
DTX heatless compressed air desiccant dryers	42
DTV Zero purge vacuum heat regenerated dryers	43

Respiratory protection and medical filtration

High efficiency breathing air purifiers	44-45
Former BA unit (oil-x plus) replacement element	46
Medical/breathing air purifiers	47
Medical air purifiers	48
Breathing air purity test kit	49
Vacuum pump inlet and exhaust filters	50
Variable temperature compressed air heaters	51
Exhaust silencer mist eliminators	51
OIL-Xplus 0003G compressed air filters	51

Compressed air and gas filtration, purification and separation products

Gas Generators

	PAGE
Maxigas	52-53
Midigas	54
Laboratory	55-58
Hydrogen	59-60
C02 Free	61
Membrane Nitrogen Generation	62-67
Process Filtration	68
Process Chillers	69
Compressed air membrane dryers	70-75
Compressed air and gas desiccant dryers (Non regenerative)	76-79
High pressure filters - compressed air and gas	80-104

The following colour codes are used throughout this Product Guide and Price List and are given for general information and guidance only. These relate to normal delivery lead times in working days. If any do not meet with your requirements, please enquire to see if we can improve upon the delivery time.



Stocked item



14 - 21 days



3 - 5 weeks



Lead time on application

* Subject to confirmation and standard terms & conditions.

ISO 8573 Compressed air quality



TO UNDERSTAND THE NEED FOR AN INTERNATIONAL STANDARD IN COMPRESSED AIR QUALITY, WE MUST FIRST OF ALL UNDERSTAND THE PROBLEMS ASSOCIATED WITH COMPRESSED AIR CONTAMINATION, THE SOURCES OF CONTAMINATION AND THE INDIVIDUAL CONTAMINANTS FOUND WITHIN A COMPRESSED AIR SYSTEM.

Sources of contamination in a compressed air system

Contaminants in a compressed air system can generally be attributed to the following:

- **The quality of the atmospheric air drawn into the compressor**

There are ten main contaminants found within a compressed air system and almost all can be directly attributed to the quality of the atmospheric air surrounding the compressor. Air compressors draw in huge amounts of this ambient air, continuously filling the system with contamination.

- **The type and operation of the air compressor**

The air compressor can also add contamination, from wear and tear particles to coolants and lubricants.

- **Compressed air storage devices and distribution systems**

The air receiver and system piping that distributes the compressed air around the facility will also store the large amounts of contamination drawn into the compressor. Additionally, they cool the warm, moist compressed air which causes condensation on a large scale and promotes corrosion within the compressed air system.

The 10 main contaminants found in a compressed air system

Water Vapour, Condensed Water and Water Aerosols

Up to 99.9% of the total liquid contamination found in a compressed air system is water. Oil is often perceived to cause the most problems as it appears to be seen emanating from open drain points and exhausting valves, however, in the majority of instances, it is actually oily condensate (oil mixed with water) that is being observed.

Atmospheric air contains water vapour (water in a gaseous form). The ability of compressed air to hold water vapour is dependent upon its temperature. The higher the temperature, the more water vapour that can be held by the air. During compression, the temperature increases significantly, which allows the heated air to easily retain the incoming moisture.

Prior to exiting the compressor, compressed air is normally cooled to a usable temperature. This reduces the air's ability to retain water vapour, resulting in a proportion of the water vapour being condensed into liquid water which is removed by a condensate drain fitted to the compressor after-cooler. The air leaving the after-cooler is now 100% saturated with water vapour and any further cooling of the air will result in more water vapour condensing into liquid water.

Condensation occurs at various stages throughout the system as the air is cooled further by the air receiver, piping and the expansion of air in valves, cylinders, tools and machinery. The condensed water and water aerosols cause corrosion to the storage and distribution system, damage production equipment and can also spoil the end product. Overall, water contamination reduces production efficiency and increases maintenance costs and must be removed to enable the system to run correctly and efficiently.

Atmospheric Dirt

Atmospheric air in an industrial environment typically contains 140 million dirt particles for every cubic metre of air. 80% of these particles are less than 2 microns in size and are too small to be captured by the compressor intake filter, therefore passing directly into the compressed air system.

Micro-organisms

Bacteria and viruses will also be drawn into the compressed air system through the compressor intake and warm, moist air provides an ideal environment for the growth of micro-organisms. Ambient air can typically contain around 3800 micro-organisms per cubic metre. If only a few micro-organisms were to enter a clean, sterile environment, or production process, enormous damage could be caused that not only diminishes product quality, but may even render a product entirely unfit for use and subject to recall.

Oil Vapour

Atmospheric air also contains oil in the form of unburned hydrocarbons which are drawn into the compressor intake. Typical concentrations can vary between 0.05 and 0.5mg per cubic metre of ambient air. Once inside the compressed air system, oil vapour will cool and condense, causing the same contamination issues as liquid oil. Vaporised oil from the compression stage of a lubricated compressor will also condense within the system and add to the overall oil contamination.

Liquid Oil and Oil Aerosols

Most air compressors use oil in the compression stage for sealing, lubrication and cooling. During operation, lubricating oil is carried over into the compressed air system as liquid oil and aerosols. This oil mixes with water in the air and is often very acidic, causing damage to the compressed air storage and distribution system, production equipment and final product.

Rust and Pipescale

Rust and pipescale can be found in air receivers and the piping of "wet systems" (systems without adequate purification equipment) or systems which were operated "wet" prior to purification equipment being installed. Over time, this contamination breaks away to cause damage or blockage in production equipment which can also contaminate final product and processes.



COMPRESSED AIR AND ITS PURIFICATION

HAVING IDENTIFIED THE DIFFERENT TYPES OF CONTAMINATION THAT CAN BE FOUND WITHIN A COMPRESSED AIR SYSTEM, WE CAN NOW EXAMINE THE PURIFICATION TECHNOLOGIES AVAILABLE FOR IT'S REMOVAL.

Coalescing Filters

Coalescing filters are probably the most important items of purification equipment in any compressed air system. They are designed to remove oil and water aerosols using mechanical filtration techniques and have the additional benefit of removing solid particulate to very low levels (as small as 0.01 micron in size).

Installed in pairs, most users believe one to be an oil removal filter and the other to be a particulate filter. Infact, the pair of filters both perform the same function. The first filter, a general purpose filter is used to protect the high efficiency filter against bulk contamination. This 'dual filter' installation ensures a continuous supply of high quality compressed air with low operational costs and minimal maintenance time.

Water Separators

Used to protect coalescing filters in systems where excessive cooling takes place in distribution piping. Water Separators will remove in excess of 90% of bulk liquid contamination.

Adsorption (Desiccant) Dryers

Water vapour is water in a gaseous form and is removed from compressed air using a dryer, with dryer performance being measured as pressure dewpoint.

Adsorption or desiccant dryers remove moisture by passing air over a regenerative adsorbent material which strips the moisture from the air. This type of dryer is extremely efficient and typical pressure dewpoint ratings are -40°C or -70°C pdp. This means that for water vapour to condense into a liquid, the air temperature would have to drop below -40°C or -70°C respectively (the actual air temperature after an adsorption dryer is not the same as it's dewpoint).

A pressure dewpoint of -26°C or better will not only prevent corrosion, but will also inhibit the growth of micro-organisms within the compressed air system.

Refrigeration Dryers

Refrigeration dryers work by cooling the air, so are limited to positive pressure dewpoint ratings to prevent freezing of the condensed liquid. Typically used for general purpose applications, they provide pressure dewpoints of +3°C, +7°C or +10°C. Refrigeration dryers are not suitable for installations where piping is installed in ambient temperatures below the dryer dewpoint i.e. systems with external piping.

Important Note Regarding Compressed Air Dryers

As adsorption and refrigeration dryers are designed to remove only water vapour and not water in a liquid form, they require the use of coalescing filters to work efficiently.

Adsorption (Activated Carbon) Filters

Oil vapour is oil in a gaseous form and as with water vapour will pass through a coalescing filter just as easily as the compressed air. Therefore, oil vapour removal filters must be employed as these provide a large bed of activated carbon adsorbent for the effective removal of oil vapour, providing the ultimate protection against oil contamination.

Dust Removal Filters

Dust removal filters are used for the retention of particulates where no liquid is present. They usually provide identical particulate removal performance to the equivalent coalescing filter and use the same mechanical filtration techniques to provide up to 99.9999% particle removal efficiency. For absolute particulate retention (100% at a given size), a sieve retention membrane filter must be used.

Micro-biological (Sterile) Filters

Absolute removal of solid particulates and micro-organisms is performed by a sieve retention or membrane filter. They are often referred to as sterile air filters as they also provide sterilised compressed air. Housings are manufactured from stainless steel to allow in-situ steam sterilisation of the filter housing and element. It is important to note that the piping between the sterile filter and the application must also be cleaned and sterilised on a regular basis.

Contamination and Types of Compressor

It is often believed that the level of compressed air purification equipment required in a system is dependent upon the type of compressor used. Contamination in a compressed air system originates from many sources and is not related solely to the compressor or it's lubricants. No matter which compressor type is selected, adequate filtration and separation products will be required to remove the large volume of oily contaminated water as well as the dirt, rust, pipescale and micro-biological contamination in the system.



OIL-X EVOLUTION
Coalescing and dust removal filters



High Flow TETPOR II
Sterile air filters



PNEUDRI
Modular adsorption dryers

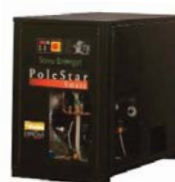

SPL/PST
Refrigerated air dryers



OVR
Oil vapour removal filters

ISO 8573 Compressed air quality



ISO 8573 – COMPRESSED AIR QUALITY STANDARDS

ISO 8573 IS THE GROUP OF INTERNATIONAL STANDARDS RELATING TO THE QUALITY OF COMPRESSED AIR AND CONSISTS OF NINE SEPARATE PARTS. PART 1 SPECIFIES THE QUALITY REQUIREMENTS OF THE COMPRESSED AIR AND PARTS 2 – 9 SPECIFY THE METHODS OF TESTING FOR A RANGE OF CONTAMINANTS.

ISO 8573.1 : 2001 is the primary document used from the ISO 8573 series and it is this document which allows the user to specify the air quality or purity required at key points in a compressed air system.

Within ISO 8573.1 : 2001 purity levels for the main contaminants are shown in separate tables, however for ease of use, this document combines all three into one easy to understand table.

The horizontal headings show the three major contaminants of solid particulate, water and oil, vertical headings show "purity classes" identified by a number.

Alongside each purity class, is a maximum permissible amount of contamination allowed per cubic metre of compressed air.

Purity Class	Solid Particulate					Water		Oil
	Maximum number of particles per m ³			Particle Size	Concentration	Vapour	Liquid	Total oil (aerosol, liquid and vapour)
	0.1 - 0.5 micron	0.5 - 1 micron	1 - 5 micron	micron	mg/m ³	Pressure Dewpoint	g/m ³	mg/m ³
0	As specified by the equipment user or supplier					As specified by the equipment user or supplier		As specified by the equipment user or supplier
1	100	1	0	-	-	-70°C	-	0.01
2	100,000	1,000	10	-	-	-40°C	-	0.1
3	-	10,000	500	-	-	-20°C	-	1
4	-	-	1,000	-	-	+3°C	-	5
5	-	-	20,000	-	-	+7°C	-	-
6	-	-	-	5	5	+10°C	-	-
7	-	-	-	40	10	-	0.5	-
8	-	-	-	-	-	-	5	-
9	-	-	-	-	-	-	10	-

Specifying Air Purity In Accordance With ISO 8573.1 : 2001

When specifying the purity of air required, the standard must always be referenced, followed by the purity class selected for each contaminant (a different purity class can be selected for each contaminant if required). An example of how to write an air quality specification is shown below :

ISO 8573.1 : 2001 Class 1.2.1

ISO 8573.1 : 2001 refers to the standard document and its revision, the three digits refer to the purity classifications selected for solid particulate, water and total oil. Selecting an air purity class of 1.2.1 would specify the following air quality when operating at the standard's reference conditions :

Class 1 Particulate

In each cubic metre of compressed air, no more than 100 particles in the 0.1 - 0.5 micron size range are allowed
 In each cubic metre of compressed air, no more than 1 particle in the 0.5 - 1 micron size range is allowed
 In each cubic metre of compressed air, no particles in the 1 - 5 micron size range are allowed

Class 2 Water

A pressure dewpoint of -40°C or better is required and no liquid water is allowed.

Class 1 Oil

In each cubic metre of compressed air, not more than 0.01mg of oil is allowed. This is a combined level for both oil aerosol and oil vapour.

ISO 8573.1 : 2001 CLASS 0

THE ISO 8573.1 : 2001 TABLE ALSO INCLUDES A CLASS 0 FOR EACH TYPE OF CONTAMINANT. SHOULD AN APPLICATION REQUIRE COMPRESSED AIR PURITY WHICH IS HIGHER THAN THE LEVELS SHOWN FOR CLASS 1, THEN CLASS 0 ALLOWS THE USER AND AN EQUIPMENT MANUFACTURER OR SUPPLIER TO AGREE THEIR OWN LEVELS WITHIN THE FOLLOWING GUIDELINES

- THE PURITY LEVELS SELECTED MUST BE MORE STRINGENT THAN THOSE OF CLASS 1
- THE PURITY LEVELS SELECTED ARE MEASURABLE WITH THE TEST EQUIPMENT AND METHODS OF ISO 8573 PARTS 2 TO 9
- THE AGREED LEVELS ARE WRITTEN AS PART OF THE AIR QUALITY SPECIFICATION

IMPORTANT NOTES

- CLASS 0 DOES NOT MEAN ZERO CONTAMINATION ALLOWED IN THE COMPRESSED AIR.
- MANUFACTURERS SHOULD NOT STATE PRODUCTS COMPLY WITH CLASS 0 UNLESS PURITY LEVELS HAVE CLEARLY BEEN DEFINED AND AGREED WITH THE USER.
- PURITY LEVELS BEYOND THE ACCURATE MEASUREMENT CAPABILITIES GIVEN IN ISO 8573 PARTS 2 TO 9 SHOULD NOT BE SELECTED AS THERE IS NO ACCURATE WAY OF VERIFYING PRODUCT PERFORMANCE
- TO OPERATE A COST EFFECTIVE COMPRESSED AIR SYSTEM, CLASS 0 SHOULD ONLY BE SPECIFIED AT THE POINT OF USE AND FOR THE MOST CRITICAL OF APPLICATIONS



ARE ALL COMPRESSED AIR FILTERS AND DRYERS THE SAME?

COMPRESSED AIR PURIFICATION EQUIPMENT IS ESSENTIAL TO ALL MODERN PRODUCTION FACILITIES. IT MUST DELIVER UNCOMPROMISING PERFORMANCE AND RELIABILITY WHILST PROVIDING THE RIGHT BALANCE OF AIR QUALITY WITH THE LOWEST COST OF OPERATION. TODAY, MANY MANUFACTURERS OFFER PRODUCTS FOR THE FILTRATION AND PURIFICATION OF CONTAMINATED COMPRESSED AIR, WHICH ARE OFTEN SELECTED ONLY UPON THEIR INITIAL PURCHASE COST, WITH LITTLE OR NO REGARD FOR THE AIR QUALITY THEY PROVIDE OR THE COST OF OPERATION THROUGHOUT THEIR LIFE. WHEN PURCHASING PURIFICATION EQUIPMENT, THE DELIVERED AIR QUALITY, COST OF OPERATION AND THE OVERALL COST OF OWNERSHIP MUST ALWAYS BE CONSIDERED.

The Parker Filtration Design Philosophy

All Parker filtration and purification products are designed with the philosophy of air quality, energy efficiency and low life time costs.



Air Quality

Compressed air purification equipment is installed to deliver high quality, clean dry air, and to eliminate the problems and costs associated with contamination. When selecting this type of equipment, the delivered air quality and the verification of performance must always be the primary driver, otherwise why install it in the first place.

Parker Filtration were instrumental in the development of the international standards for compressed air quality and OIL-X EVOLUTION is not only the first filter range specifically designed to comply with the stringent requirements of ISO 12500.1, it is also the first to have 3rd party performance validation in accordance with the new standard.

Lloyd's Register	Independent Performance Validation in Accordance with			
	ISO 12500.1 OIL AEROSOL	ISO 8573.2 OIL AEROSOL	ISO 8573.4 SOLID PARTICULATE	ISO 8573.5 OIL VAPOUR
Coalescing filters	✓	✓	✓	X
Dry Particulate filters	X	X	✓	X
Oil Vapour Removal filters	X	X	X	✓
Micro-biological filters	X	X	✓	X

Energy Efficiency

After air quality, the next consideration when selecting compressed purification equipment is the cost of operation. Pressure loss is the major contributor to operational costs of filtration products. Parker Filtration OIL-X EVOLUTION filters have been designed using aerospace technology to ensure pressure loss and thus energy consumption is kept to an absolute minimum.

By also considering pressure losses after 12 months of operation and not just at start-up, energy savings in excess of 60% compared to an ordinary filter are not uncommon.

Parker adsorption dryers offer minimal pressure losses and are also optimised to ensure regeneration costs are minimised. Energy management systems are available to further reduce operational costs during periods where the water vapour entering the dryer is reduced whether it is due to ambient conditions, shift patterns, variable air demand or a combination of all three.

Low Lifetime Costs

Equipment with a low purchase cost may turn out to be a very costly investment in the longer term. Always consider the initial purchase cost,

plus the cost of operating and maintaining the purification equipment. In addition, consider the cost to your business of poor air quality. By guaranteeing air quality and ensuring energy consumption is kept to a minimum, Parker Filtration purification equipment can reduce the total cost of ownership and improve your bottom line through improved manufacturing efficiencies.

Materials of Construction

In addition to air quality standards, the materials used to construct the OIL-X EVOLUTION filter range have also been independently verified to comply with FDA Code of Federal Regulations, Title 21 'Food and Drug'. Making them suitable for use in critical applications such as food, beverage, pharmaceutical & breathing air.

Guaranteed Air Quality

All products (excluding adsorption filters) are supplied with a one year compressed air quality guarantee, when sized, installed and maintained in accordance with Parker recommendations. The air quality guarantee is automatically extended by replacing the filter element and consumable items with genuine parts annually.

ISO 8573 Compressed air quality



TESTING AND VALIDATION

OF THE NINE PARTS THAT MAKE UP ISO 8573, PARTS 2 TO 9 ARE USED TO SPECIFY THE METHODS AND EQUIPMENT REQUIRED TO ACCURATELY TEST FOR CONTAMINANTS IN COMPRESSED AIR.

On-site testing using ISO 8573 Test Methods

On-site testing is often difficult due to the complexity of the test method and the expense of test equipment required and for this reason all Parker filtration products have been tested in accordance with the relevant parts of ISO 8573 with performance independently validated by Lloyds Register, one of the world's largest risk management organisations.

Using the standards to select and purchase purification products

Presenting product data in this way should allow users to easily compare the performance of purification products from different manufacturers and cost effectively meet the air quality requirements of their application, however the ISO 8573 test methods were primarily developed to verify air quality in a compressed air system, not test purification equipment, therefore not all products claiming compliance with the standards are tested in the same way.

To accurately detect contaminants in a compressed system and show compliance with the selected purity levels from ISO 8573.1, the equipment and methods shown in ISO 8573 parts 2 to 9 must be used.

These test methods can also be used to test the performance of purification equipment, however for this purpose, they contain a major omission, one which makes comparison and selection of compressed air filters extremely difficult for the user.

The vital piece of information which is missing when testing products is a challenge concentration. So even though different manufacturers claim their products meet a certain purity class, they will most likely have been tested with differing concentrations of contamination entering the product and as challenge concentrations are rarely included in technical data, filter performance which may look similar or identical on paper, can provide significantly different results when installed in a compressed air system.

Introducing ISO 12500

The ISO 8573 air quality standards were introduced to assist, not confuse compressed air users, so to overcome the problems

associated with selecting products, a new standard has been introduced. This will complement the existing ISO 8573 series. The new standard, ISO 12500, will consist of three parts, with ISO 12500.1 covering the testing of compressed air coalescing filters for oil aerosol (liquid) removal, ISO 12500.2 to determine the adsorption capacity of oil vapour removal filters and ISO 12500.3 covering the testing of solid particulate filters. Parts one and two were released in June 2007, with part three to follow.

ISO 12500.1 – Testing of Coalescing Filters

ISO 12500.1 has introduced two challenge concentrations of oil aerosol to be used when testing coalescing filters, these are 40mg/m³ and 10mg/m³. The new standard requires filters to be tested using the existing test method and equipment shown in ISO 8573.2 whilst using one of the two challenge concentrations.

In addition to this, ISO 12500.1 requires filters to be "wetted out" which is representative of a filter in operation. Recording of the filters initial saturated pressure drop has also been included, again to give a more accurate and representative indication of the filters operational costs.

Three filters of each size must be tested and each filter tested three times. Published performance data is then an average of all the tests in order to provide the person selecting a new product with a more representative indication of performance.

ISO 12500.2 – Testing of Adsorption Filters

ISO 12500.2 has been introduced to assist users when selecting oil vapour removal filters or adsorption filters. Adsorption filters have a finite ability to remove oil vapour and when their capacity is used up, they must be replaced. ISO 12500.2 is an accelerated test of a filters adsorption capacity.

As the test is accelerated, the results must not be misinterpreted as the actual lifetime of the filter element or cartridge, it's purpose is to indicate which filter has the largest adsorption capacity and hence will require changing less frequently.

ISO 12500.3 – Testing of Particulate Removal Filters

ISO 12500.3 is not currently released.

 LRQ4003083	 LRQ4001479	INTERNATIONAL APPROVALS		 BRITISH COMPRESSED AIR SOCIETY LIMITED	
		ASME VIII	 MEMBER COMPRESSED AIR AND GAS INSTITUTE		
	CRN	AS1210			

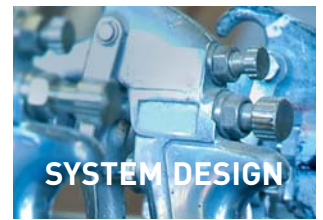

OPTIMISED SYSTEM DESIGN FOR TYPICAL APPLICATIONS

THE QUALITY OF AIR REQUIRED THROUGHOUT A TYPICAL COMPRESSED AIR SYSTEM CAN VARY. THE EXTENSIVE RANGE OF PURIFICATION EQUIPMENT AVAILABLE FROM PARKER FILTRATION ALLOWS THE USER TO SPECIFY THE QUALITY OF AIR FOR EVERY APPLICATION, FROM GENERAL PURPOSE RING MAIN PROTECTION, THROUGH TO CRITICAL CLEAN DRY AIR (CDA) POINT OF USE SYSTEMS.

PARKER FILTRATION HAS COMPREHENSIVE RANGES OF PURIFICATION EQUIPMENT AVAILABLE TO EXACTLY MATCH SYSTEM REQUIREMENTS, ENSURING BOTH CAPITAL AND OPERATIONAL COSTS ARE KEPT TO A MINIMUM.

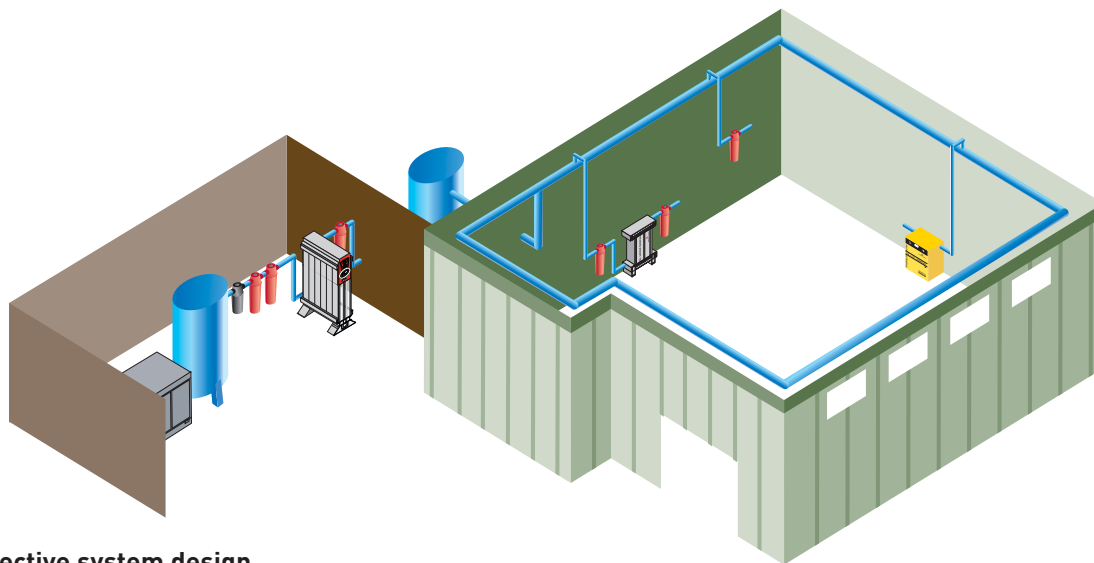

Cost effective system design

To achieve the stringent air quality levels required for today's modern production facilities, a careful approach to system design, commissioning and operation must be employed. Treatment at one point alone is not enough and it is highly recommended that the compressed air is treated prior to entry into the distribution system to a quality level suitable for protecting air receivers and distribution piping. Point of use purification should also be employed, with specific attention being focussed on the application and the level of air quality required. This approach to system design ensures that air is not "over treated" and provides the most cost effective solution to high quality compressed air.

The following table highlights the Parker Filtration filtration and drying products required to achieve each air purity classification shown in ISO 8573.1 : 2001. If a Class 0 purity level is required, contact Parker Filtration for recommendations regarding product requirements.

ISO 8573.1:2001 CLASS	SOLID PARTICULATE		WATER	OIL
	WET PARTICULATE	DRY PARTICULATE	VAPOUR	TOTAL OIL (AEROSOL LIQUID and VAPOUR)
1	OIL-X EVOLUTION Grade AO + AA + TETPOR II	OIL-X EVOLUTION Grade AR + AAR + TETPOR II	PNEUDRI ADSORPTION DRYER -70°C PDP	OIL-X EVOLUTION Grade AO + AA + OVR OIL-X EVOLUTION Grade AO + AA +ACS OIL-X EVOLUTION Grade AO + AC
2	OIL-X EVOLUTION Grade AO + AA	OIL-X EVOLUTION Grade AR + AAR	PNEUDRI ADSORPTION DRYER -40°C PDP	OIL-X EVOLUTION Grade AO + AA
3	OIL-X EVOLUTION Grade AO	OIL-X EVOLUTION Grade AR	PNEUDRI ADSORPTION DRYER -20°C PDP	OIL-X EVOLUTION Grade AO
4	OIL-X EVOLUTION Grade AO	OIL-X EVOLUTION Grade AR	REFRIGERATION DRYER +3°C PDP	OIL-X EVOLUTION Grade AO
5	OIL-X EVOLUTION Grade AO	OIL-X EVOLUTION Grade AR	REFRIGERATION DRYER +7°C PDP	-
6	-	-	REFRIGERATION DRYER +10°C PDP	-

Simple guidelines for the selection of purification equipment

1. Purification equipment is installed to provide air quality and you must first of all identify the quality of compressed air required for your system. Each usage point in the system may require a different quality of compressed air dependent upon the application. Using the quality classification's shown in ISO 8573.1 : 2001 will allow your equipment supplier to quickly and easily select the correct purification equipment necessary for each part of the system.
2. ISO 8573.1 : 2001 is the latest edition of the standard. Ensure it is written in full when contacting suppliers. Specifying air quality as "ISO 8573.1" or "ISO 8573.1 : 1991" refers to the previous edition of the standard and may result in a lower quality of delivered compressed air.
3. Ensure that the equipment under consideration will actually provide delivered air quality in accordance with the quality classifications you have selected from ISO 8573.1 :2001.
4. When comparing coalescing filters, ensure that they have been tested in accordance with both the ISO 8573.2, ISO 8573.4 & ISO 12500.1 standards.
5. Ask for independent validation of product performance by a 3rd party.
6. For peace of mind, ensure the manufacturer provides a written guarantee of delivered air quality.
7. Oil-free compressor installations require the same filtration considerations as oil lubricated compressor installations.
8. When considering the operational costs of coalescing filters, only compare the initial saturated pressure loss as dry pressure loss is not representative of performance in a normally wet compressed air system. ISO 12500.1 requires pressure losses for coalescing filters to be recorded when the element is saturated
9. Look at the blockage characteristics of the filter. Just because it has a low starting dp, doesn't mean it will remain low throughout the filter element's lifetime. Energy costs should always be calculated based upon the blockage characteristics of the filter, not just initial saturated dp.
10. Look at the total cost of ownership for purification equipment (purchase cost, operational costs and maintenance costs), a low initial purchase price, may look inviting, but may end up costing significantly more in terms of poor air quality and high operational costs.

CRITICAL APPLICATIONS

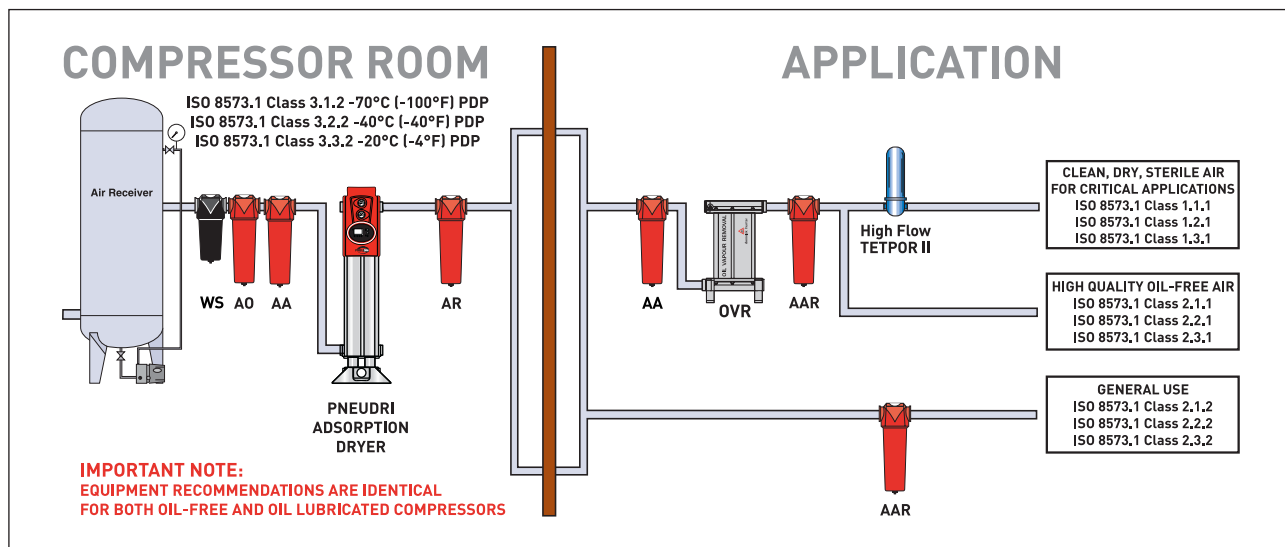

Typical Applications

- | | |
|--|---|
| Pharmaceutical products | Hard disk manufacturing |
| Silicon wafer manufacturing | Foodstuffs |
| TFT / LCD Screen manufacturing | Dairies |
| Memory device manufacturing | Breweries |
| Optical storage devices (CD, CD/RW, DVD, DVD/RW) | CDA systems for electronics manufacturing |
| Optical disk manufacturing (CD's/DVD's): | |

HIGH QUALITY OIL-FREE AIR

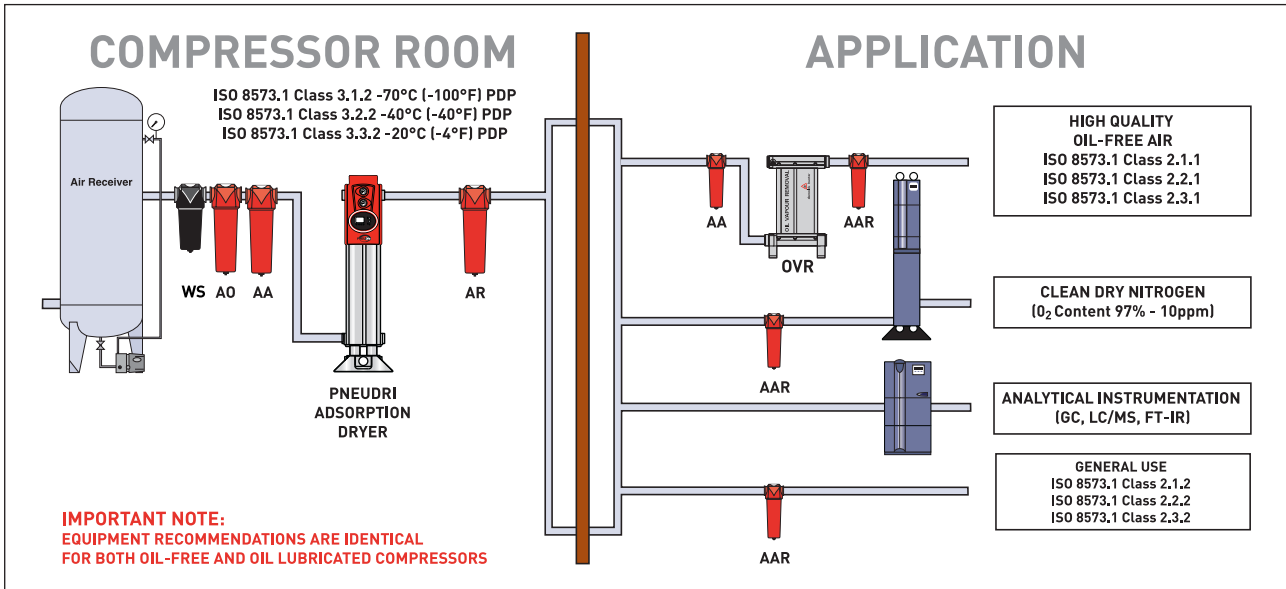

Typical Applications

Blow Moulding of Plastics e.g. P.E.T. Bottles
 Film processing
 Critical instrumentation
 Advanced pneumatics
 Air blast circuit breakers
 Decompression chambers

Cosmetic production
 Medical air
 Dental air
 Lasers and optics
 Robotics
 Spray Painting

Air bearings
 Pipeline purging
 Measuring equipment
 Blanketing
 Modified Atmosphere Packaging
 Pre-treatment for on-site gas generation

GENERAL PURPOSE OIL-FREE AIR

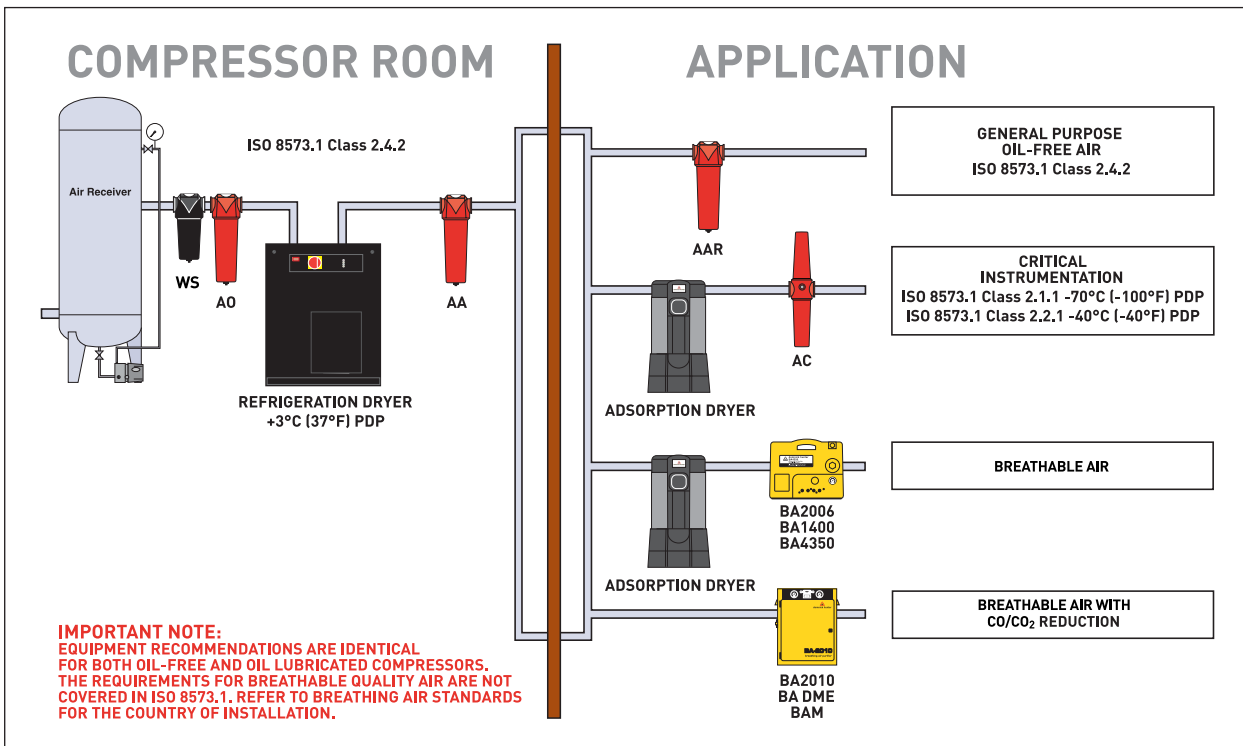

Typical Applications

General ring main protection
 Pre-filtration to point of use adsorption air dryers
 Plant automation
 Air Logistics
 Pneumatic tools

General instrumentation
 Metal stamping
 Forging
 General industrial assembly (no external pipework)
 Air conveying
 Air motors

Workshop (Tools)
 Garage (Tyre filling)
 Temperature control systems
 Blow guns
 Gauging equipment
 Raw material mixing
 Sand / bead blasting

OIL-X EVOLUTION Water Separators

Bulk liquid removal



Technical data

Filter Grade	Filter Models	Max. Operating Pressure		Max. Recommended Operating Temp	Min. Recommended Operating Temp
		bar g	psi g		
WS	010ABFX - 055JBFX	16	232	80°C	1.5°C
	1000	16	232	60°C	1.5°C
	250F - 7200F	16	232	60°C	1.5°C

The Parker Water Separator is a patented design which has a very high efficiency across its flow range.

Model	Pipe Size	Flow Rates*			Dimensions mm			Weight Kg	UNIT PRICE \$
		m³/min	m³/hr	cfm	A	B	C		
WS010ABFX	¼"	0.6	36	21	76	181.5	153	0.6	266.00
WS010BBFX	⅜"	0.6	36	21	76	181.5	153	0.6	266.00
WS010CBFX	½"	0.6	36	21	76	181.5	153	0.6	266.00
WS015BBFX	⅜"	2.4	144	85	97.5	235	201	1.1	355.00
WS020CBFX	½"	2.4	144	85	97.5	235	201	1.1	355.00
WS020DBFX	¾"	2.4	144	85	97.5	235	201	1.1	355.00
WS020EBFX	1"	2.4	144	85	97.5	235	201	1.1	355.00
WS025DBFX	¾"	6.6	396	233	129	275	232.5	2.2	569.00
WS030EBFX	1"	6.6	396	233	129	275	232.5	2.2	569.00
WS030FBFX	1½"	6.6	396	233	129	275	232.5	2.2	569.00
WS030GBFX	1½"	6.6	396	233	129	275	232.5	2.2	569.00
WS035FBFX	1½"	21	1260	742	170	432.5	382.5	5.1	1014.00
WS040GBFX	1½"	21	1260	742	170	432.5	382.5	5.1	1014.00
WS045HBFX	2"	21	1260	742	170	432.5	382.5	5.1	1014.00
WS055IBFX	2½"	48	2880	1695	205	505	444.5	10	2401.00
WS055JBFX	3"	48	2880	1695	205	505	444.5	10	2401.00

*Stated flows are for operation at 7 bar (g) (102 psi g) with reference to 20°C, 1 bar (a), 0% relative water vapour pressure.

Notes

1. Fitted with automatic drain as standard.

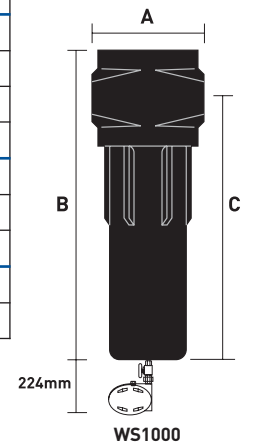
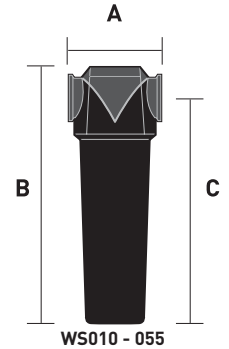

Flow correction factors (WS010 - WS055)

Line Pressure	bar g	1	2	3	4	5	6	7	8	9	10	11	12	13	14	15	16
	psi g	15	29	44	58	73	87	100	116	131	145	160	174	189	203	218	232
Correction Factor		0.25	0.38	0.50	0.63	0.75	0.88	1.00	1.06	1.12	1.17	1.22	1.27	1.32	1.37	1.41	1.46

Model	Pipe Size	Flow Rates*			Dimensions mm			Weight Kg	UNIT PRICE \$
		m³/min	m³/hr	cfm	A	B	C		
WS1000	G4	60	3600	2119	312	993	911	41	P.O.A.
WS250F	DN40	21	1260	742	304	727	555	32	P.O.A.
WS800F	DN80	48	2880	1695	370	1199	974	70	P.O.A.
WS1000F	DN100	60	3600	2119	450	1241	993	105	P.O.A.
WS1800F	DN150	108	6480	3814	580	1424	1090	200	P.O.A.
WS3000F	DN200	180	10800	6357	750	1687	1277	400	P.O.A.
WS4800F	DN250	288	17280	10171	862	1821	1352	540	P.O.A.
WS7200F	DN300	421	25920	14885	1000	1910	1377	700	P.O.A.

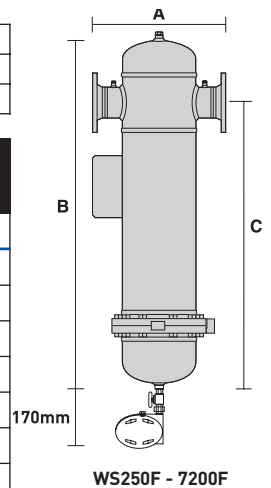

Flow correction factors (WS1000 - WS7200F)

Line Pressure	bar g	1	2	3	4	5	6	7	8	9	10	11	12	13	14	15	16
	psi g	15	29	44	58	73	87	100	116	131	145	160	174	189	203	218	232
Correction Factor		0.38	0.53	0.65	0.76	0.85	0.93	1.00	1.07	1.13	1.19	1.25	1.31	1.36	1.41	1.46	1.51

OIL-X EVOLUTION

Flow rates, weights and dimensions



Model	Pipe Size	Flow Rates*			Dimensions mm			Weight Kg
		m³/min	m³/hr	cfm	A	B	C	
005A	¼"	0.4	22	13	76	154.5	126.5	0.5
005B	⅜"	0.4	22	13	76	154.5	126.5	0.5
005C	½"	0.4	22	13	76	154.5	126.5	0.5
010A	¼"	0.6	36	21	76	181.5	153	0.4
010B	⅜"	0.6	36	21	76	181.5	153	0.4
010C	½"	0.6	36	21	76	181.5	153	0.4
015B	⅜"	1.2	72	42	97.5	235	201	1
015C	½"	1.2	72	42	97.5	235	201	1
020C	½"	1.8	108	64	97.5	235	201	1
020D	¾"	1.8	108	64	97.5	235	201	1
020E	1"	1.8	108	64	97.5	235	201	1
025D	¾"	3.6	216	127	129	275	232.5	2.2
025E	1"	3.6	216	127	129	275	232.5	2.2
030E	1"	6.6	396	233	129	364.5	322	2.6
030F	1¼"	6.6	396	233	129	364.5	322	2.6
030G	1½"	6.6	396	233	129	364.5	322	2.6
035F	1¼"	9.6	576	339	170	432.5	382.5	4.5
035G	1½"	9.6	576	339	170	432.5	382.5	4.5
040G	1½"	13.2	792	466	170	524.5	474.5	5.25
040H	2"	13.2	792	466	170	524.5	474.5	5.25
045H	2"	19.8	1188	699	170	524.5	474.5	5.25
050I	2½"	25.9	1548	911	205	641.5	581.5	10
050J	3"	25.9	1548	911	205	641.5	581.5	10
055I	2½"	37.3	2232	1314	205	832	772	12
055J	3"	37.3	2232	1341	205	832	772	12
060K	4"	60	3600	2119	420	1071	765	44.5
100MD	DN50	13.2	792	466	304	800	680	32.5
150ND	DN80	25.9	1548	911	370	980	755	60
200ND	DN80	37.3	2232	1314	370	1220	995	70
2500D	DN100	60	3600	2119	500	1325	1052	150
3000D	DN100	78	4680	2755	500	1325	1052	150
350PD	DN150	117	7020	4132	580	1424	1090	200
400QD	DN200	195	11700	6887	750	1687	1277	400
450RD	DN250	313	18720	11019	862	1821	1352	540
500SD	DN300	469	28080	16528	1000	1910	1377	700

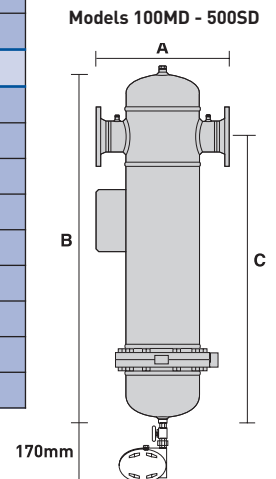
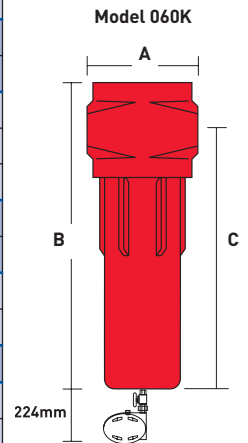
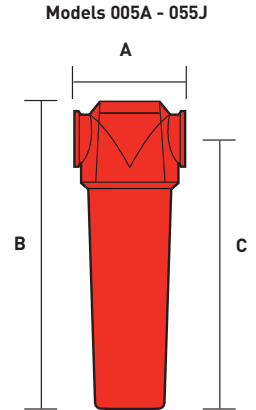

*Stated flows are for operation at 7 bar g (102 psi g) with reference to 20°C, 1 bar (a), 0% relative water vapour pressure. For flow rates at other pressures, please refer to flow correction factors below.

EVOLUTION Filter flow correction factors (Models 005 - 500)

Line Pressure	bar g	1	2	3	4	5	6	7	8	9	10	11	12	13	14	15	16	17	18	19	20
	psi g	15	29	44	58	73	87	100	116	131	145	160	174	189	203	218	232	247	261	275	290
Correction Factor		0.38	0.53	0.65	0.76	0.85	0.93	1.00	1.07	1.13	1.19	1.25	1.31	1.36	1.41	1.46	1.51	1.56	1.60	1.65	1.70

To find the Correction factor for 8.5 bar g (122psi g) = $\sqrt{\frac{\text{System Operating Pressure}}{\text{Nominal pressure}}} = \sqrt{\frac{8.5 \text{ bar g}}{7 \text{ bar g}}} = 1.10$

When ordering an AQ/AA filter for pressures above 16 bar g (232 psi g), use manual drain. Replace F with M in product code. e.g. 015B8FX now 015B8MX

OIL-X EVOLUTION Grade AO

High efficiency general purpose protection



Technical data

Filter Grade	Filter Models	Max. Operating Pressure		Max. Recommended Operating Temp	Min. Recommended Operating Temp
		bar g	psi g		
AO	005ABFX - 055JBFX	16	232	80°C	1.5°C
	005ABMX - 055JBMX	20	290	100°C	1.5°C
	060KBFX	16	232	66°C	1.5°C
	060KBMX	20	290	100°C	1.5°C
	100MDFX - 500SDFX	16	232	66°C	1.5°C
	100MDMX - 500SDMX	16	232	100°C	1.5°C

Particle removal down to 1 micron, including water and oil aerosols.
Maximum remaining oil aerosol content: 0.6mg/m³ at 21°C.

Model	Pipe Size	Flow Rates*			UNIT PRICE \$
		m ³ /min	m ³ /hr	cfm	
AO 005ABFX	1/4"	0.4	22	13	374.00
AO 005BBFX	3/8"	0.4	22	13	374.00
AO 005CBFX	1/2"	0.4	22	13	374.00
AO 010ABFX	1/4"	0.6	36	21	387.00
AO 010BBFX	3/8"	0.6	36	21	387.00
AO 010CBFX	1/2"	0.6	36	21	387.00
AO 015BBFX	3/8"	1.2	72	42	482.00
AO 015CBFX	1/2"	1.2	72	42	482.00
AO 020CBFX	1/2"	1.8	108	64	536.00
AO 020DBFX	3/4"	1.8	108	64	536.00
AO 020EBFX	1"	1.8	108	64	536.00
AO 025DBFX	3/4"	3.6	216	127	911.00
AO 025EBFX	1"	3.6	216	127	911.00
AO 030EBFX	1"	6.6	396	233	1020.00
AO 030FBFX	1 1/4"	6.6	396	233	1020.00
AO 030GBFX	1 1/2"	6.6	396	233	1020.00
AO 035FBFX	1 1/4"	9.6	576	339	1548.00
AO 035GBFX	1 1/2"	9.6	576	339	1548.00
AO 040GBFX	1 1/2"	13	792	466	1982.00
AO 040HBFX	2"	13	792	466	1982.00
AO 045HBFX	2"	20	1188	699	2721.00
AO 050IBFX	2 1/2"	26	1548	911	3330.00
AO 050JBFX	3"	26	1548	911	3330.00
AO 055IBFX	2 1/2"	37	2232	1314	3796.00
AO 055JBFX	3"	37	2232	1314	3796.00
AO 060KBFX	4"	60	3600	2119	6288.00
AO 100MDFX	DN50	13	792	466	P.O.A.
AO 150NDFX	DN80	26	1548	911	P.O.A.
AO 200NDFX	DN80	37	2232	1314	P.O.A.
AO 250ODFX	DN100	60	3600	2119	P.O.A.
AO 300ODFX	DN100	79	4680	2755	P.O.A.
AO 350PDFX	DN150	117	7020	4132	P.O.A.
AO 400QDFX	DN200	195	11700	6886	P.O.A.
AO 450RDFX	DN250	312	18720	11018	P.O.A.
AO 500SDFX	DN300	468	28080	16527	P.O.A.

Replacement Element Kit	No.	UNIT PRICE \$
005AO	1	108.00
005AO	1	108.00
005AO	1	108.00
010AO	1	115.00
010AO	1	115.00
010AO	1	115.00
010AO	1	115.00
015AO	1	184.00
015AO	1	184.00
020AO	1	213.00
020AO	1	213.00
020AO	1	213.00
025AO	1	264.00
025AO	1	264.00
030AO	1	308.00
030AO	1	308.00
030AO	1	308.00
035AO	1	347.00
035AO	1	347.00
040AO	1	413.00
040AO	1	413.00
045AO	1	592.00
050AO	1	695.00
050AO	1	695.00
055AO	1	937.00
055AO	1	937.00
060AO	3	595.00
100AO	1	413.00
150AO	1	695.00
200AO	1	937.00
060AO	3	595.00
060AO	4	595.00
060AO	6	595.00
060AO	10	595.00
060AO	16	595.00
060AO	24	595.00

*Stated flows are for operation at 7 bar g (102 psi g) with reference to 20°C, 1 bar (a), 0% relative water vapour pressure.

Notes

1. Fitted with automatic drain as standard. Manual drain available.
2. Differential pressure incident monitor supplied as an optional extra (not available on 010 models).
3. For flow rates at other pressures, please refer to flow correction factors on page 10.
4. Optional accessories on page 18.

OIL-X EVOLUTION Grade AA

High efficiency oil removal filtration



Technical data

Filter Grade	Filter Models	Max. Operating Pressure		Max. Recommended Operating Temp	Min. Recommended Operating Temp
		bar g	psi g		
AA	005ABFX - 055JBFX	16	232	80°C	1.5°C
	005ABMX - 055JBMX	20	290	100°C	1.5°C
	060KBFX	16	232	66°C	1.5°C
	060KBMX	20	290	100°C	1.5°C
	100MDFX - 500SDFX	16	232	66°C	1.5°C
	100MDMX - 500SDMX	16	232	100°C	1.5°C

Particle removal down to 0.01 micron, including water and oil aerosols.
Maximum remaining oil content: 0.01mg/m³ at 21°C.

Model	Pipe Size	Flow Rates*			UNIT PRICE \$
		m ³ /min	m ³ /hr	cfm	
AA 005ABFX	¼"	0.4	22	13	374.00
AA 005BBFX	⅜"	0.4	22	13	374.00
AA 005CBFX	½"	0.4	22	13	374.00
AA 010ABFX	¼"	0.6	36	21	387.00
AA 010BBFX	⅜"	0.6	36	21	387.00
AA 010CBFX	½"	0.6	36	21	387.00
AA 015BBFX	⅜"	1.2	72	42	482.00
AA 015CBFX	½"	1.2	72	42	482.00
AA 020CBFX	½"	1.8	108	64	536.00
AA 020DBFX	¾"	1.8	108	64	536.00
AA 020EBFX	1"	1.8	108	64	536.00
AA 025DBFX	¾"	3.6	216	127	911.00
AA 025EBFX	1"	3.6	216	127	911.00
AA 030EBFX	1"	6.6	396	233	1020.00
AA 030FBFX	1¼"	6.6	396	233	1020.00
AA 030GBFX	1½"	6.6	396	233	1020.00
AA 035FBFX	1¼"	9.6	576	339	1548.00
AA 035GBFX	1½"	9.6	576	339	1548.00
AA 040GBFX	1½"	13	792	466	1982.00
AA 040HBFX	2"	13	792	466	1982.00
AA 045HBFX	2"	20	1188	699	2721.00
AA 050IBFX	2½"	26	1548	911	3330.00
AA 050JBFX	3"	26	1548	911	3330.00
AA 055IBFX	2½"	37	2232	1314	3796.00
AA 055JBFX	3"	37	2232	1314	3796.00
AA 060KBFX	4"	60	3600	2119	6288.00
AA 100MDFX	DN50	13	792	466	P.O.A.
AA 150NDFX	DN80	26	1548	911	P.O.A.
AA 200NDFX	DN80	37	2232	1314	P.O.A.
AA 250ODFX	DN100	60	3600	2119	P.O.A.
AA 300ODFX	DN100	79	4680	2755	P.O.A.
AA 350PDFX	DN150	117	7020	4132	P.O.A.
AA 400QDFX	DN200	195	11700	6886	P.O.A.
AA 450RDFX	DN250	312	18720	11018	P.O.A.
AA 500SDFX	DN300	468	28080	16527	P.O.A.

Replacement Element Kit	No.	UNIT PRICE \$
005AA	1	108.00
005AA	1	108.00
005AA	1	108.00
010AA	1	115.00
010AA	1	115.00
010AA	1	115.00
015AA	1	184.00
015AA	1	184.00
020AA	1	213.00
020AA	1	213.00
020AA	1	213.00
025AA	1	264.00
025AA	1	264.00
030AA	1	308.00
030AA	1	308.00
030AA	1	308.00
035AA	1	347.00
035AA	1	347.00
040AA	1	413.00
040AA	1	413.00
045AA	1	592.00
050AA	1	695.00
050AA	1	695.00
055AA	1	937.00
055AA	1	937.00
060AA	3	595.00
100AA	1	413.00
150AA	1	695.00
200AA	1	937.00
060AA	3	595.00
060AA	4	595.00
060AA	6	595.00
060AA	10	595.00
060AA	16	595.00
060AA	24	595.00

*Stated flows are for operation at 7 bar g (102 psi g) with reference to 20°C, 1 bar (a), 0% relative water vapour pressure.

Notes

1. Fitted with automatic drain as standard. Manual drain available.
2. Differential pressure incident monitor supplied as an optional extra (not available on 010 models).
3. For flow rates at other pressures, please refer to flow correction factors on page 10.
4. Optional accessories on page 18.

OIL-X EVOLUTION Grade AR

General purpose dust filtration



Technical data

Filter Grade	Filter Models	Max. Operating Pressure		Max. Recommended Operating Temp	Min. Recommended Operating Temp
		bar g	psi g		
AR	005ABMX - 055JBMX	20	290	100°C	1.5°C
	060KBMX	20	290	100°C	1.5°C
	100MDMX - 500SDMX	16	232	100°C	1.5°C

Dry particle removal down to 1 micron

Model	Pipe Size	Flow Rates*			UNIT PRICE \$
		m³/min	m³/hr	cfm	
AR 005ABMX	¼"	0.4	22	13	374.00
AR 005BBMX	⅜"	0.4	22	13	374.00
AR 005CBMX	½"	0.4	22	13	374.00
AR 010ABMX	¼"	0.6	36	21	387.00
AR 010BBMX	⅜"	0.6	36	21	387.00
AR 010CBMX	½"	0.6	36	21	387.00
AR 015BBMX	⅜"	1.2	72	42	482.00
AR 015CBMX	½"	1.2	72	42	482.00
AR 020CBMX	½"	1.8	108	64	536.00
AR 020DBMX	¾"	1.8	108	64	536.00
AR 020EBMX	1"	1.8	108	64	536.00
AR 025DBMX	¾"	3.6	216	127	911.00
AR 025EBMX	1"	3.6	216	127	911.00
AR 030EBMX	1"	6.6	396	233	1020.00
AR 030FBMX	1½"	6.6	396	233	1020.00
AR 030GBMX	1½"	6.6	396	233	1020.00
AR 035FBMX	1½"	9.6	576	339	1548.00
AR 035GBMX	1½"	9.6	576	339	1548.00
AR 040GBMX	1½"	13	792	466	1982.00
AR 040HBMX	2"	13	792	466	1982.00
AR 045HBMX	2"	20	1188	699	2721.00
AR 050IBMX	2½"	26	1548	911	3330.00
AR 050JBMX	3"	26	1548	911	3330.00
AR 055IBMX	2½"	37	2232	1314	3796.00
AR 055JBMX	3"	37	2232	1314	3796.00
AR 060KBMX	4"	60	3600	2119	6288.00
AR 100MDMX	DN50	13	792	466	P.O.A.
AR 150NDMX	DN80	26	1548	911	P.O.A.
AR 200NDMX	DN80	37	2232	1314	P.O.A.
AR 250ODMX	DN100	60	3600	2119	P.O.A.
AR 300ODMX	DN100	79	4680	2755	P.O.A.
AR 350PDMX	DN150	117	7020	4132	P.O.A.
AR 400QDMX	DN200	195	11700	6886	P.O.A.
AR 450RDMX	DN250	312	18720	11018	P.O.A.
AR 500SDMX	DN300	468	28080	16527	P.O.A.

Replacement Element Kit	No.	UNIT PRICE \$
005AR	1	108.00
005AR	1	108.00
005AR	1	108.00
010AR	1	115.00
010AR	1	115.00
010AR	1	115.00
015AR	1	184.00
015AR	1	184.00
020AR	1	213.00
020AR	1	213.00
020AR	1	213.00
025AR	1	264.00
025AR	1	264.00
030AR	1	308.00
030AR	1	308.00
030AR	1	308.00
035AR	1	347.00
035AR	1	347.00
040AR	1	413.00
040AR	1	413.00
045AR	1	592.00
050AR	1	695.00
050AR	1	695.00
055AR	1	937.00
055AR	1	937.00
060AR	3	595.00
100AR	1	413.00
150AR	1	695.00
200AR	1	937.00
060AR	3	595.00
060AR	4	595.00
060AR	6	595.00
060AR	10	595.00
060AR	16	595.00
060AR	24	595.00

*Stated flows are for operation at 7 bar g (102 psi g) with reference to 20°C, 1 bar (a), 0% relative water vapour pressure.

Notes

1. Fitted with manual drain as standard.
2. Differential pressure incident monitor supplied as an optional extra (not available on 010 models).
3. For flow rates at other pressures, please refer to flow correction factors on page 10.
4. Optional accessories on page 18.

OIL-X EVOLUTION Grade AAR

High efficiency dust filtration



Technical data

Filter Grade	Filter Models	Max. Operating Pressure		Max. Recommended Operating Temp	Min. Recommended Operating Temp
		bar g	psi g		
AAR	005ABMX - 055JBMX	20	290	100°C	1.5°C
	060KBMX	20	290	100°C	1.5°C
	100MDMX - 500SDMX	16	232	100°C	1.5°C

Dry particle removal down to 0.01 micron

Model	Pipe Size	Flow Rates*			UNIT PRICE \$	Replacement Element Kit	No.	UNIT PRICE \$
		m³/min	m³/hr	cfm				
AAR 005ABMX	¼"	0.4	22	13	374.00	005AAR	1	108.00
AAR 005BBMX	⅜"	0.4	22	13	374.00	005AAR	1	108.00
AAR 005CBMX	½"	0.4	22	13	374.00	005AAR	1	108.00
AAR 010ABMX	¼"	0.6	36	21	387.00	010AAR	1	115.00
AAR 010BBMX	⅜"	0.6	36	21	387.00	010AAR	1	115.00
AAR 010CBMX	½"	0.6	36	21	387.00	010AAR	1	115.00
AAR 015BBMX	⅜"	1.2	72	42	482.00	015AAR	1	184.00
AAR 015CBMX	½"	1.2	72	42	482.00	015AAR	1	184.00
AAR 020CBMX	½"	1.8	108	64	536.00	020AAR	1	213.00
AAR 020DBMX	¾"	1.8	108	64	536.00	020AAR	1	213.00
AAR 020EBMX	1"	1.8	108	64	536.00	020AAR	1	213.00
AAR 025DBMX	¾"	3.6	216	127	911.00	025AAR	1	264.00
AAR 025EBMX	1"	3.6	216	127	911.00	025AAR	1	264.00
AAR 030EBMX	1"	6.6	396	233	1020.00	030AAR	1	308.00
AAR 030FBMX	1¼"	6.6	396	233	1020.00	030AAR	1	308.00
AAR 030GBMX	1½"	6.6	396	233	1020.00	030AAR	1	308.00
AAR 035FBMX	1¼"	9.6	576	339	1548.00	035AAR	1	347.00
AAR 035GBMX	1½"	9.6	576	339	1548.00	035AAR	1	347.00
AAR 040GBMX	1½"	13	792	466	1982.00	040AAR	1	413.00
AAR 040HBMX	2"	13	792	466	1982.00	040AAR	1	413.00
AAR 045HBMX	2"	20	1188	699	2721.00	045AAR	1	592.00
AAR 050IBMX	2½"	26	1548	911	3330.00	050AAR	1	695.00
AAR 050JBMX	3"	26	1548	911	3330.00	050AAR	1	695.00
AAR 055IBMX	2½"	37	2232	1314	3796.00	055AAR	1	937.00
AAR 055JBMX	3"	37	2232	1314	3796.00	055AAR	1	937.00
AAR 060KBMX	4"	60	3600	2119	6288.00	060AAR	3	595.00
AAR 100MDMX	DN50	13	792	466	P.O.A.	100AAR	1	413.00
AAR 150NDMX	DN80	26	1548	911	P.O.A.	150AAR	1	695.00
AAR 200NDMX	DN80	37	2232	1314	P.O.A.	200AAR	1	937.00
AAR 2500DMX	DN100	60	3600	2119	P.O.A.	060AAR	3	595.00
AAR 3000DMX	DN100	79	4680	2755	P.O.A.	060AAR	4	595.00
AAR 350PDMX	DN150	117	7020	4132	P.O.A.	060AAR	6	595.00
AAR 400QDMX	DN200	195	11700	6886	P.O.A.	060AAR	10	595.00
AAR 450RDMX	DN250	312	18720	11018	P.O.A.	060AAR	16	595.00
AAR 500SDMX	DN300	468	28080	16527	P.O.A.	060AAR	24	595.00

*Stated flows are for operation at 7 bar g (102 psi g) with reference to 20°C, 1 bar (a), 0% relative water vapour pressure.

Notes

1. Fitted with manual drain as standard.
2. Differential pressure incident monitor supplied as an optional extra (not available on 010 models).
3. For flow rates at other pressures, please refer to flow correction factors on page 10.
4. Optional accessories on page 18.

OIL-X EVOLUTION Grade ACS

Oil vapour and odour removal



Technical data

Filter Grade	Filter Models	Max. Operating Pressure		Max. Recommended Operating Temp	Min. Recommended Operating Temp
		bar g	psi g		
ACS	005ABMX - 055JBMX	20	290	50°C	1.5°C
	060KBMX	20	290	50°C	1.5°C
	100MDMX - 500SDMX	16	232	50°C	1.5°C

Maximum remaining oil vapour content: 0.003mg/m³ at 21°C

Model	Pipe Size	Flow Rates*			UNIT PRICE \$
		m ³ /min	m ³ /hr	cfm	
ACS 005ABMX	1/4"	0.4	22	13	374.00
ACS 005BBMX	3/8"	0.4	22	13	374.00
ACS 005CBMX	1/2"	0.4	22	13	374.00
ACS 010ABMX	1/4"	0.6	36	21	387.00
ACS 010BBMX	3/8"	0.6	36	21	387.00
ACS 010CBMX	1/2"	0.6	36	21	387.00
ACS 015BBMX	3/8"	1.2	72	42	482.00
ACS 015CBMX	1/2"	1.2	72	42	482.00
ACS 020CBMX	1/2"	1.8	108	64	536.00
ACS 020DBMX	3/4"	1.8	108	64	536.00
ACS 020EBMX	1"	1.8	108	64	536.00
ACS 025DBMX	3/4"	3.6	216	127	911.00
ACS 025EBMX	1"	3.6	216	127	911.00
ACS 030EBMX	1"	6.6	396	233	1020.00
ACS 030FBMX	1 1/4"	6.6	396	233	1020.00
ACS 030GBMX	1 1/2"	6.6	396	233	1020.00
ACS 035FBMX	1 1/4"	9.6	576	339	1548.00
ACS 035GBMX	1 1/2"	9.6	576	339	1548.00
ACS 040GBMX	1 1/2"	13	792	466	1982.00
ACS 040HBMX	2"	13	792	466	1982.00
ACS 045HBMX	2"	20	1188	699	2721.00
ACS 050IBMX	2 1/2"	26	1548	911	3330.00
ACS 050JBMX	3"	26	1548	911	3330.00
ACS 055IBMX	2 1/2"	37	2232	1314	3796.00
ACS 055JBMX	3"	37	2232	1314	3796.00
ACS 060KBMX	4"	60	3600	2119	6288.00
ACS 100MDMX	DN50	13	792	466	P.O.A.
ACS 150NDMX	DN80	26	1548	911	P.O.A.
ACS 200NDMX	DN80	37	2232	1314	P.O.A.
ACS 250ODMX	DN100	60	3600	2119	P.O.A.
ACS 300ODMX	DN100	79	4680	2755	P.O.A.
ACS 350PDMX	DN150	117	7020	4132	P.O.A.
ACS 400QDMX	DN200	195	11700	6886	P.O.A.
ACS 450RDMX	DN250	312	18720	11018	P.O.A.
ACS 500SDMX	DN300	468	28080	16527	P.O.A.

Replacement Element Kit	No.	UNIT PRICE \$
005ACS	1	108.00
005ACS	1	108.00
005ACS	1	108.00
010ACS	1	115.00
010ACS	1	115.00
010ACS	1	115.00
015ACS	1	184.00
015ACS	1	184.00
020ACS	1	213.00
020ACS	1	213.00
020ACS	1	213.00
025ACS	1	264.00
025ACS	1	264.00
030ACS	1	308.00
030ACS	1	308.00
030ACS	1	308.00
035ACS	1	347.00
035ACS	1	347.00
040ACS	1	413.00
040ACS	1	413.00
045ACS	1	592.00
050ACS	1	695.00
050ACS	1	695.00
055ACS	1	937.00
055ACS	1	937.00
060ACS	3	595.00
100ACS	1	413.00
150ACS	1	695.00
200ACS	1	937.00
060ACS	3	595.00
060ACS	4	595.00
060ACS	6	595.00
060ACS	10	595.00
060ACS	16	595.00
060ACS	24	595.00

*Stated flows are for operation at 7 bar g (102 psi g) with reference to 20°C, 1 bar (a), 0% relative water vapour pressure.

Notes

1. Fitted with manual drain as standard.
2. Differential pressure incident monitor supplied as an optional extra (not available on 010 models).
3. For flow rates at other pressures, please refer to flow correction factors on page 10.
4. Optional accessories on page 18.

OIL-X EVOLUTION Grade AC

Point of use oil vapour and odour removal



Technical data

Filter Grade	Filter Models	Max. Operating Pressure		Max. Recommended Operating Temp	Min. Recommended Operating Temp
		bar g	psi g		
AC	AC010ABFI - AC030GBFI	16	232	30°C	1.5°C

Maximum remaining oil vapour content: 0.003mg/m³ at 21°C

Model	Pipe Size	Flow Rates*			Dimensions mm			Weight Kg	UNIT PRICE \$	Replacement Elements			
		m ³ /min	m ³ /hr	cfm	A	B	C			1st Stage	UNIT PRICE \$	2nd Stage	UNIT PRICE \$
AC010ABFI	1/4"	0.4	22	13	76	153.5	311.5	0.81	426.00	010AA	115.00	010AC	66.00
AC010BBFI	3/8"	0.4	22	13	76	153.5	311.5	0.81	426.00	010AA	115.00	010AC	66.00
AC010CBFI	1/2"	0.4	22	13	76	153.5	311.5	0.81	426.00	010AA	115.00	010AC	66.00
AC015BBFI	3/8"	0.8	46	27	97.5	235	474.5	1.60	494.00	015AA	184.00	015AC	84.00
AC015CBFI	1/2"	0.8	46	27	97.5	235	474.5	1.60	494.00	015AA	184.00	015AC	84.00
AC020CBFI	1/2"	1.5	90	53	97.5	235	474.5	1.45	868.00	020AA	213.00	020AC	115.00
AC020DBFI	3/4"	1.5	90	53	97.5	235	474.5	1.45	868.00	020AA	213.00	020AC	115.00
AC020EBFI	1"	1.5	90	53	97.5	235	474.5	1.45	868.00	020AA	213.00	020AC	115.00
AC025DBFI	3/4"	2.4	143	84	129	275	554	3.54	1335.00	025AA	264.00	025DAC	176.00
AC025EBFI	1"	3.9	231	136	129	275	554	3.43	1335.00	025AA	264.00	025EAC	176.00
AC030EBFI	1"	5.1	305	180	129	364	733	4.10	1480.00	030AA	308.00	030AC	364.00
AC030FBFI	1 1/4"	5.1	305	180	129	364	733	4.10	1480.00	030AA	308.00	030AC	364.00
AC030GBFI	1 1/2"	5.1	305	180	129	364	733	4.10	1480.00	030AA	308.00	030AC	364.00

*Stated flows are for operation at 7 bar g (102 psi g) with reference to 20°C, 1 bar (a), 0% relative water vapour pressure.

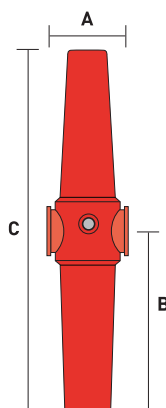

Selecting a AC model to match a system flow rate and pressure.

Example: System flow 24 m³/hr at a pressure of 8.5 bar g

1. Obtain pressure correction factor from table on page 10. Correction factor for 8.5 bar g = 1.10
2. Divide system flow by correction factor to give equivalent flow rate at 7 bar g 24m³/hr ÷ 1.10 = 21 m³/hr (at 7 bar g)
3. Select a filter model from the above table with a flow rate above or equal to 21 m³/hr. AC filter model selected : 010
4. Select pipe connection & Thread type System uses 1/2" piping and BSP threads : Model AC010CB
5. Select drain type Pressure is below 16 bar g (232 psi g), automatic float drain fitted as standard. Model AC010CBF
6. Bulk oil indicator supplied as standard.

Notes

1. Fitted with automatic drain as standard. Manual drain available.
2. For flow rates at other pressures, please refer to flow correction factors on page 5.
3. Optional accessories on page 18.

OIL-X EVOLUTION Grade OVR

High efficiency oil vapour removal



Technical data

Filter Grade	Filter Models	Max. Operating Pressure		Max. Recommended Operating Temp	Min. Recommended Operating Temp
		bar g	psi g		
OVR	OVR100EBXX-OVR250JBXX	16	232	50°C	1.5°C

Maximum remaining oil vapour content : 0.003 mg/m³ at 21°C.

Model	Pipe Size	Flow rates*			UNIT PRICE \$
		m ³ /min	m ³ /hr	cfm	
OVR100EBXX	1"	4.8	288	170	3697.00
OVR150HBXX	2"	9.6	576	339	4385.00
OVR200HBXX	2"	19.8	1188	699	8765.00
OVR250JBXX	3"	37.2	2232	1314	10041.00
2 x OVR250JBXX	3"	74.5	4465	2628	
3 x OVR250JBXX	3"	111.8	6696	3941	
4 x OVR250JBXX	3"	149.1	8928	5255	
5 x OVR250JBXX	3"	186.4	11160	6569	

Replacement Cartridge Kit	Quantity Required	UNIT PRICE \$
100OVR	1	886.00
100OVR	2	886.00
100OVR	4	886.00
100OVR	6	886.00

Cartridge Life: Approx. 6000 hours (when corrected to match system conditions)

* Stated flows are at 7 barg (102 psi g) ANR conditions. For flows at other conditions, apply the correction factors shown below.

Filter selection

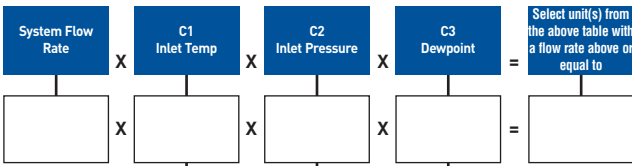

C1 Inlet Air Temperature °C	Correction Factor
20	1.00
25	1.53
30	2.33
35	3.55
40	5.47
45	8.55
50	13.23

C2 Inlet Air Pressure		Correction Factor
bar g	psi g	
3	43.5	2.00
4	58	1.60
5	72	1.33
6	87	1.14
7	102	1.00
8	116	1.00
9	130	1.00
10	145	1.00
11	160	1.00
12	174	1.00
13	189	1.00
14	203	1.00
15	218	1.00
16	232	1.00

C3 Dewpoint	°C	Correction Factor
Dry	-70 to +3	1.00
Wet	+3 and above	2.00

It is assumed inlet oil vapour concentration does not exceed 0.05mg/m³ at 21°C (70°F). For applications with higher oil vapour concentrations, please contact Parker for accurate sizing.

Weights and dimensions

Filter Grade	Pipe Size	Dimensions mm			Weight Kg
		A	B	C	
OVR100E	1"	352	670	250	25
OVR150H	2"	504	797	300	42
OVR200H	2"	829	797	300	74
OVR250J	3"	1194	816	300	107

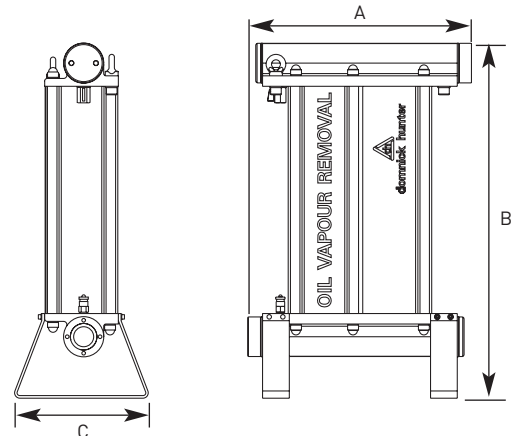

OIL-X EVOLUTION

Filter accessories - 1/4" to 3" models



Incident monitor

Used to indicate premature high differential pressure. Indicator can be retrofitted to existing housings without depressurising the system.



FXKE Fixing Clamps

Fixing clamp allows quick and simple connection of multiple filter housings.



MBKE Mounting Brackets

Mounting brackets provide additional support to filters installed in flexible piping systems or OEM equipment.

Incident Monitor

Filter Model		UNIT PRICE \$
015 - 055	DPM	77.00
100 - 500	DPM-FAB	185.00

Filter Fixing Clamp Kits

Filter Model		UNIT PRICE \$
005 - 010	FXKE1	69.00
015 - 020	FXKE2	69.00
025 - 030	FXKE3	85.00
035 - 045	FXKE4	88.00
050 - 055	FXKE5	99.00

MBKE Mounting Bracket Kits

Filter Model		UNIT PRICE \$
005 - 010	MBKE1	94.00
015 - 020	MBKE2	97.00
025 - 030	MBKE3	104.00
035 - 045	MBKE4	129.00
050 - 055	MBKE5	150.00

Replacement Drains



AO/AA Grade filters fitted with float drains as standard.

EF1 Float drain	77.00
-----------------	-------



AR/AAR/ACS Grade filters fitted with a manual drain.

EM1 Manual drain	77.00
------------------	-------

BULK OIL INDICATOR

60500 9902	92.00
------------	-------

O Ring Kits

Filter Model		UNIT PRICE \$
005 - 010	EMAK1	24.00
015 - 020	EMAK2	33.00
025 - 030	EMAK3	35.00
035 - 045	EMAK4	42.00
050 - 055	EMAK5	47.00

EMAK

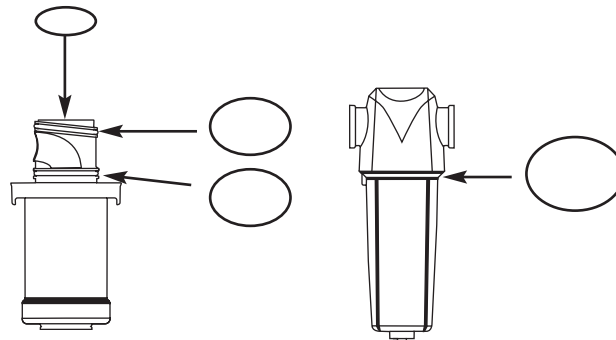

OIL-Xplus

Filter accessories

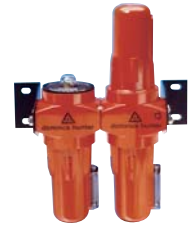

	<p>Manual Drain Kit (0009G - 0145G) Part No. 69203 \$38.00</p>		<p>Automatic Drain Kit (0006G/0009G) Part No. 60864 LF \$72.00</p> <p>Automatic Drain (0017G - 0145G) Part No. 60864 \$72.00</p>		<p>External Drain Kit (0205G - 0620G) Part No. 60807 \$350.00</p>																								
	<p>HDF120/A Heavy Duty External Drain Kit \$259.00</p>		<p>1/2" BSPT Manual Drain Kit Part No. 60 500 6470 \$77.00</p>		<p>Sight Glass Kit Part No. SGK1 \$61.00</p> <p>Sight Glass Blanking Kit Part No. 60 500 2120 \$61.00</p>																								
		<p>Fixing Kit 2 wedges, 'O' ring and screws for connecting 2 filters in series</p>		<p>Differential Pressure Indicators</p> <p>DPG Differential Pressure Gauge 0058G - 1000G \$310.00</p> <p>DPI (Ported Filters) 0009G - 0030G \$160.00</p>																									
<p>Mounting Bracket Kits (includes 2 brackets, 2 wedges and screws, nuts and bolts)</p> <p>MBK1 0009G \$80.00 MBK2 0017G to 0030G \$96.00 MBK3 0058G to 0145G \$120.00 MBK4 0205G to 0330G \$179.00 MBK5 0405G to 0620G \$414.00</p>				<p>DPS Differential Pressure Switch \$75.00</p>																									
<p>Replacement 'O' ring kits (includes body 'O' ring, autodrain gasket and bleed valve)</p> <p>0009G MAK1 \$25.00 0017G to 0030G MAK2 \$27.00 0058G to 0145G MAK3 \$38.00 0205G to 0330G MAK4 \$45.00 0405G to 0620G MAK5 \$49.00</p>		<p>Body seal for: 1000G and WS1000 MAK6 \$31.00</p> <p>Full seal kit for: 1000G and WS1000 MAK7 \$58.00</p>		<p>For Flanged Filters Part No. DPG-KIT \$474.00</p> <p>(PF/AO/AA/AR/AAR)</p>																									
<p>Fabricated Filter Body Gasket</p> <table> <tbody> <tr><td>0330F</td><td>FAK1</td><td>\$32.00</td></tr> <tr><td>0620F</td><td>FAK2</td><td>\$95.00</td></tr> <tr><td>1000F</td><td>FAK3</td><td>\$116.00</td></tr> <tr><td>1300F</td><td>FAK4</td><td>\$134.00</td></tr> <tr><td>1950F</td><td>FAK5</td><td>\$192.00</td></tr> <tr><td>3250F</td><td>FAK6</td><td>\$353.00</td></tr> <tr><td>5200F</td><td>FAK7</td><td>\$429.00</td></tr> <tr><td>7200F</td><td>FAK8</td><td>\$658.00</td></tr> </tbody> </table>						0330F	FAK1	\$32.00	0620F	FAK2	\$95.00	1000F	FAK3	\$116.00	1300F	FAK4	\$134.00	1950F	FAK5	\$192.00	3250F	FAK6	\$353.00	5200F	FAK7	\$429.00	7200F	FAK8	\$658.00
0330F	FAK1	\$32.00																											
0620F	FAK2	\$95.00																											
1000F	FAK3	\$116.00																											
1300F	FAK4	\$134.00																											
1950F	FAK5	\$192.00																											
3250F	FAK6	\$353.00																											
5200F	FAK7	\$429.00																											
7200F	FAK8	\$658.00																											

Genuine Parker Filtration

Replacement filter elements



OIL-Xplus replacement elements for OIL-X filters (1994 - 2004)										
Housing Type	PF	UNIT PRICE \$	AO/AR	UNIT PRICE \$	AA	UNIT PRICE \$	AX	UNIT PRICE \$	ACS	UNIT PRICE \$
0009G	K009PF	113.00	K009AO	113.00	K009AA	113.00	K009AX	137.00	K009ACS	113.00
0017G	K017PF	179.00	K017AO	179.00	K017AA	179.00	K017AX	219.00	K017ACS	179.00
0030G	K030PF	208.00	K030AO	208.00	K030AA	208.00	K030AX	252.00	K030ACS	208.00
0058G	K058PF	258.00	K058AO	258.00	K058AA	258.00	K058AX	313.00	K058ACS	258.00
0080G	K145PF	340.00	K145AO	340.00	K145AA	340.00	K145AX	411.00	K145ACS	340.00
0125G	K145PF	340.00	K145AO	340.00	K145AA	340.00	K145AX	411.00	K145ACS	340.00
0145G	K145PF	340.00	K145AO	340.00	K145AA	340.00	K145AX	411.00	K145ACS	340.00
0205G	K220PF	403.00	K220AO	403.00	K220AA	403.00	K220AX	487.00	K220ACS	403.00
0220G	K220PF	403.00	K220AO	403.00	K220AA	403.00	K220AX	487.00	K220ACS	403.00
0330G	K330PF	579.00	K330AO	579.00	K330AA	579.00	K330AX	702.00	K330ACS	579.00
0405G	K430PF	679.00	K430AO	679.00	K430AA	679.00	K430AX	824.00	K430ACS	679.00
0430G	K430PF	679.00	K430AO	679.00	K430AA	679.00	K430AX	824.00	K430ACS	679.00
0620G	K620PF	917.00	K620AO	917.00	K620AA	917.00	K620AX	1117.00	K620ACS	917.00
1000G	K330PF*	579.00	K330AO*	579.00	K330AA*	579.00	K330AX*	702.00	K330ACS*	579.00

*3 Filter elements required

OIL-Xplus Activated Carbon Replacement Elements			
Housing Type	Element Code	Quantity	UNIT PRICE \$
AC-0006G	K009AA	1	113.00
	K006AC	1	63.00
AC-0013G	K017AA	1	179.00
	K013AC	1	81.00
AC-0025G	K030AA	1	208.00
	K025AC	1	113.00
AC-0040G	K058AA	1	258.00
	K040AC	1	171.00
AC-0065G	K145AA	1	340.00
	K065AC	1	261.00
AC-0085G	K145AA	1	340.00
	K085AC	1	355.00



OIL-Xplus TS Series Elements		
AO	AA	UNIT PRICE \$
K009AOTS	K009AATS	127.00
K017AOTS	K017AATS	200.00
K030AOTS	K030AATS	229.00
K058AOTS	K058AATS	269.00
K145AOTS	K145AATS	352.00
K220AOTS	K220AATS	413.00
K330AOTS	K330AATS	613.00
K430AOTS	K430AATS	700.00
K620AOTS	K620AATS	985.00

Medical vacuum filter elements	
Code	UNIT PRICE \$
K025PL	265.00
K040PL	309.00
K085PL	364.00
K195PL	494.00
K400PL	1007.00
K500PL	1220.00

HC Filter elements	
Element Code	UNIT PRICE \$
K006HC	366.00
K013HC	522.00
K035HC	790.00
K040HC	825.00

Alternative compressed air filter elements



Donaldson ultrafilter Ltd alternative compressed air filter elements

Donaldson ultrafilter Ltd.		Parker Filtration	UNIT PRICE \$
PE 02/05	V-PE02/05	PF02/05	79.00
PE 02/10	V-PE02/10	PF02/10	95.00
PE 03/05	V-PE03/05	PF03/05	95.00
PE 03/10	V-PE03/10	PF03/10	98.00
PE 04/10	V-PE04/10	PF04/10	120.00
PE 04/20	V-PE04/20	PF04/20	152.00
PE 05/20	V-PE05/20	PF05/20	188.00
PE 05/25	V-PE05/25	PF05/25	235.00
PE 07/25	V-PE07/25	PF07/25	291.00
PE 07/30	V-PE07/30	PF07/30	368.00
PE 10/30	V-PE10/30	PF10/30	426.00
PE 15/30	V-PE15/30	PF15/30	543.00
PE 20/30	V-PE20/30	PF20/30	648.00
PE 30/30	V-PE30/30	PF30/30	807.00
PE 30/50	V-PE30/50	PF30/50	1050.00

Donaldson ultrafilter Ltd.	Parker Filtration	UNIT PRICE \$
V-2/1.5	PF2/1.5	84.00
V-3/1	PF3/1	125.00
V-3/1.5	PF3/1.5	139.00
V-4/1.5	PF4/1.5	175.00
V-4/2.5	PF4/2.5	197.00
V-5/2.5	PF5/2.5	270.00
V-5/3	PF5/3	317.00
V-10/3	PF10/3	412.00
V-15/3	PF15/3	526.00
V-20/3	PF20/3	626.00
V-30/3	PF30/3	781.00
V-30/5	PF30/5	995.00

Donaldson ultrafilter Ltd.		Parker Filtration	UNIT PRICE \$
FF 02/05	MF02/05	A002/05	95.00
FF 02/10	MF02/10	A002/10	98.00
FF 03/05	MF03/05	A003/05	98.00
FF 03/10	MF03/10	A003/10	104.00
FF 04/10	MF04/10	A004/10	139.00
FF 04/20	MF04/20	A004/20	175.00
FF 05/20	MF05/20	A005/20	197.00
FF 05/25	MF05/25	A005/25	247.00
FF 07/25	MF07/25	A007/25	292.00
FF 07/30	MF07/30	A007/30	383.00
FF 10/30	MF10/30	A010/30	450.00
FF 15/30	MF15/30	A015/30	582.00
FF 20/30	MF20/30	A020/30	703.00
FF 30/30	MF30/30	A030/30	887.00
FF 30/50	MF30/50	A030/50	1086.00

Donaldson ultrafilter Ltd.	Parker Filtration	UNIT PRICE \$	
FF2/1.5	MF2/1.5	A0 2/1.5	84.00
FF3/1	MF3/1	A0 3/1	125.00
FF3/1.5	MF3/1.5	A0 3/1.5	139.00
FF4/1.5	MF4/1.5	A0 4/1.5	175.00
FF4/2.5	MF4/2.5	A0 4/2.5	197.00
FF5/2.5	MF5/2.5	A0 5/2.5	270.00
FF5/3	MF5/3	A0 5/3	317.00
FF10/3	MF10/3	A0 10/3	412.00
FF15/3	MF15/3	A0 15/3	526.00
FF20/3	MF20/3	A0 20/3	648.00
FF30/3	MF30/3	A0 30/3	781.00
FF30/5	MF30/5	A0 30/5	995.00

Donaldson ultrafilter Ltd.	Parker Filtration	UNIT PRICE \$
SMF02/05	AA02/05	98.00
SMF02/10	AA02/10	98.00
SMF03/05	AA03/05	98.00
SMF03/10	AA03/10	104.00
SMF04/10	AA04/10	139.00
SMF04/20	AA04/20	188.00
SMF05/20	AA05/20	210.00
SMF05/25	AA05/25	291.00
SMF07/25	AA07/25	305.00
SMF07/30	AA07/30	426.00
SMF10/30	AA10/30	485.00
SMF15/30	AA15/30	616.00
SMF20/30	AA20/30	703.00
SMF30/30	AA30/30	941.00
SMF30/50	AA30/50	1195.00

Donaldson ultrafilter Ltd.	Parker Filtration	UNIT PRICE \$
SMF2/1.5	AA2/1.5	97.00
SMF3/1	AA3/1	125.00
SMF3/1.5	AA3/1.5	139.00
SMF4/1.5	AA4/1.5	175.00
SMF4/2.5	AA4/2.5	197.00
SMF5/2.5	AA5/2.5	270.00
SMF5/3	AA5/3	317.00
SMF10/3	AA10/3	412.00
SMF15/3	AA15/3	526.00
SMF20/3	AA20/3	648.00
SMF30/3	AA30/3	781.00
SMF30/5	AA30/5	995.00

Donaldson ultrafilter Ltd.	Parker Filtration	UNIT PRICE \$
AK02/05	AC02/05	98.00
AK02/10	AC02/10	98.00
AK03/05	AC03/05	104.00
AK03/10	AC03/10	125.00
AK04/10	AC04/10	152.00
AK04/20	AC04/20	188.00
AK05/20	AC05/20	235.00
AK05/25	AC05/25	291.00
AK07/25	AC07/25	336.00
AK07/30	AC07/30	441.00
AK10/30	AC10/30	543.00
AK15/30	AC15/30	649.00
AK20/30	AC20/30	804.00
AK30/30	AC30/30	1018.00
AK30/50	AC30/50	1285.00

Donaldson ultrafilter Ltd.	Parker Filtration	UNIT PRICE \$
AK2/1.5	AC2/1.5	152.00
AK3/1	AC3/1	152.00
AK3/1.5	AC3/1.5	175.00
AK4/1.5	AC4/1.5	210.00
AK4/2.5	AC4/2.5	263.00
AK5/2.5	AC5/2.5	317.00
AK5/3	AC5/3	404.00
AK10/3	AC10/3	526.00
AK15/3	AC15/3	873.00
AK20/3	AC20/3	804.00
AK30/3	AC30/3	1003.00
AK30/5	AC30/5	1285.00

Busch. Ltd. alternative vacuum pump filters

Busch	domnick hunter	UNIT PRICE \$
532 - 221	DH - 221	66.00
532 - 302	DH - 222	80.00
532 - 303	DH - 223	126.00
532 - 304	DH - 224	138.00

Alternative compressed air filter elements



Walker Filtration Ltd alternative compressed air filter elements

COARSE FILTRATION		
Walker Filtration Ltd.	Parker Filtration	UNIT PRICE \$
E361 X25	EW361 PF	145.00
E371 X25	EW371 PF	215.00
E511 X25	EW511 PF	240.00
E711 X25	EW711 PF	347.00
E811 X25	EW811 PF	445.00
E731 X25	EW731 PF	432.00
E821 X25	EW821 PF	488.00
E831 X25	EW831 PF	582.00
E851 X25	EW851 PF	719.00
E1251 X25	EW1251 PF	847.00
E1261 X25	EW1261 PF	1121.00
E1281 X25	EW1281 PF	1322.00
E830 X25	EW830 PF	488.00
E86 X25	EW86 PF	702.00
E137 X25	EW137 PF	1078.00
E138 X25	EW138 PF	1356.00
E87 X25	EW87 PF	753.00

MEDIUM FILTRATION		UNIT PRICE \$
E361 X5	EW361 AO	145.00
E371 X5	EW371 AO	215.00
E511 X5	EW511 AO	240.00
E711 X5	EW711 AO	347.00
E811 X5	EW811 AO	445.00
E731 X5	EW731 AO	432.00
E821 X5	EW821 AO	488.00
E831 X5	EW831 AO	582.00
E851 X5	EW851 AO	719.00
E1251 X5	EW1251 AO	847.00
E1261 X5	EW1261 AO	1121.00
E1281 X5	EW1281 AO	1322.00
E830 X5	EW830 AO	488.00
E86 X5	EW86 AO	702.00
E137 X5	EW137 AO	1078.00
E138 X5	EW138 AO	1356.00
E87 X5	EW87 AO	753.00

FINE FILTRATION		UNIT PRICE \$
E361 X1	EW361 AO	145.00
E371 X1	EW371 AO	215.00
E511 X1	EW511 AO	240.00
E711 X1	EW711 AO	347.00
E811 X1	EW811 AO	445.00
E731 X1	EW731 AO	432.00
E821 X1	EW821 AO	488.00
E831 X1	EW831 AO	582.00
E851 X1	EW851 AO	719.00
E1251 X1	EW1251 AO	847.00
E1261 X1	EW1261 AO	1121.00
E1281 X1	EW1281 AO	1322.00
E830 X1	EW830 AO	488.00
E86 X1	EW86 AO	702.00
E137 X1	EW137 AO	1078.00
E138 X1	EW138 AO	1356.00
E87 X1	EW87 AO	753.00

HIGH EFFICIENCY FILTRATION		
Walker Filtration Ltd.	Parker Filtration	UNIT PRICE \$
E361 XA	EW361 AA	145.00
E371 XA	EW371 AA	215.00
E511 XA	EW511 AA	240.00
E711 XA	EW711 AA	347.00
E811 XA	EW811 AA	445.00
E731 XA	EW731 AA	432.00
E821 XA	EW821 AA	488.00
E831 XA	EW831 AA	582.00
E851 XA	EW851 AA	719.00
E1251 XA	EW1251 AA	847.00
E1261 XA	EW1261 AA	1121.00
E1281 XA	EW1281 AA	1322.00
E830 XA	EW830 AA	488.00
E86 XA	EW86 AA	702.00
E137 XA	EW137 AA	1078.00
E138 XA	EW138 AA	1356.00
E87 XA	EW87 AA	753.00

ACTIVATED CARBON		UNIT PRICE \$
E1251 AC	EW1251 AC	847.00
E1261 AC	EW1261 AC	1121.00
E1281 AC	EW1281 AC	1322.00
E830 AC	EW830 AC	488.00
E86 AC	EW86 AC	702.00
E137 AC	EW137 AC	1078.00
E138 AC	EW138 AC	1356.00
E87 AC	EW87 AC	753.00
E01AC	EW01 AC	150.00
E02AC	EW02 AC	137.00

Walker Filtration Ltd.	Parker Filtration	UNIT PRICE \$
E50 (Grade)	EW50 (Grade)	201.00
E51 (Grade)	EW51 (Grade)	240.00
E52 (Grade)	EW52 (Grade)	250.00
E71 (Grade)	EW71 (Grade)	347.00
E81 (Grade)	EW81 (Grade)	360.00
E73 (Grade)	EW73 (Grade)	455.00
E83 (Grade)	EW83 (Grade)	488.00
E831 (Grade)	EW831 (Grade)	582.00
E103 (Grade)	EW103 (Grade)	582.00
E123 (Grade)	EW123 (Grade)	710.00
E125 (Grade)	EW125 (Grade)	850.00
E127 (Grade)	EW127 (Grade)	1125.00
E128 (Grade)	EW128 (Grade)	1326.00
E830 (Grade)	EW830 (Grade)	488.00
E86 (Grade)	EW86 (Grade)	702.00
E137 (Grade)	EW137 (Grade)	1078.00
E138 (Grade)	EW138 (Grade)	1356.00
E87 (Grade)	EW87 (Grade)	753.00

FILTRATION GRADES	
Walker Filtration Ltd.	Parker Filtration
X25	PF
X5/X1	AO
XA	AA
AC/RAC	AC
RX25	PF Reverse flowed
RX5/RX1	AO Reverse flowed
RXA	AA Reverse flowed

NOTE* Suffix filter codes with relevant filter grades from table above.

Filter Upgrade: Contact Parker Filtration

OIL-Xplus 50 Series

Intermediate pressure filters



Filter Type	Port Size	Flow Rates			UNIT PRICE \$
		m³/min	Nm³/hr	cfm	
IP50 - (Grade)-0030G	G¼	1.8	108	64	1286.00
IP50 - (Grade)-0045G	G½	2.7	162	95	1375.00
IP50 - (Grade)-0095G	G½	5.7	342	201	1637.00
IP50 - (Grade)-0145G	G¾	8.7	522	307	1956.00
IP50 - (Grade)-0285G	G1	17.1	1026	604	2526.00
IP50 - (Grade)-0465G	G1½	27.9	1674	985	3527.00
IP50 - (Grade)-0965G	G2	57.9	3473	2044	4987.00

Replacement Element Kit	UNIT PRICE \$
K009 (grade)	113.00
K009 (grade)	113.00
K030 (grade)	208.00
K030 (grade)	208.00
K145 (grade)	340.00
K145 (grade)	340.00
K220 (grade)	403.00

Weights and dimensions

Filter Type	Dimensions mm				Weight Kg
	A	B	C	D	
IP50 - (Grade)-0030G	78	33	142	70	1.3
IP50 - (Grade)-0045G	78	33	142	70	1.3
IP50 - (Grade)-0095G	89	40.5	205	130	2.0
IP50 - (Grade)-0145G	89	40.5	205	130	2.0
IP50 - (Grade)-0285G	122	58.5	365	272	5.0
IP50 - (Grade)-0465G	122	58	365	272	5.0
IP50 - (Grade)-0965G	170	62	418	320	10.0

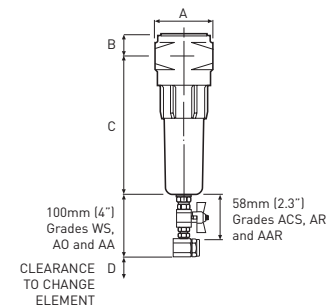

Technical data

	GRADE WS	GRADE AO	GRADE AA	GRADE ACS	GRADE AR	GRADE AAR
Particle removal down to:	-	1 micron	0.01 micron	-	1 micron	0.01 micron
Max. remaining oil content at 21°C (70°F):	-	0.6 mg/m³ (0.5 ppm)	0.01 mg/m³ (0.01 ppm)	0.003 mg/m³ (0.003 ppm)	-	-
Max. operating pressure:	50 bar g (725 psi g)	50 bar g (725 psi g)	50 bar g (725 psi g)	50 bar g (725 psi g)	50 bar g (725 psi g)	50 bar g (725 psi g)
Max. recommended operating temp:	66°C (150°F)	66°C (150°F)	66°C (150°F)	30°C (86°F)	66°C (150°F)	66°C (150°F)
Min. recommended operating temp:	1.5°C (35°F)	1.5°C (35°F)	1.5°C (35°F)	1.5°C (35°F)	1.5°C (35°F)	1.5°C (35°F)
Initial dry pressure differential:	70 mbar (1.0 psi)	70 mbar (1.0 psi)	100 mbar (1.5 psi)	70 mbar (1.0 psi)	70 mbar (1.0 psi)	100 mbar (1.5 psi)
Initial saturated pressure differential:	-	140 mbar (2 psi)	200 mbar (3 psi)	-	-	-
Change element every:	-	12 months	12 months	When oil vapour is detected	-	12 months 12

NOTES

- Automatic drain fitted as standard on grades AO and AA
- Manual ball valve fitted as standard on grades ACS, AR and AAR.
- Grade ACS will NOT remove methane, carbon dioxide, carbon monoxide or other toxic gases or fumes.
- Filters for pressures up to 350 bar g on request.

Use the correction factors below for flow rates at other working pressures:

Line Pressure	bar g	20	25	30	35	40	45	50
	psi g	290	362	435	507	580	652	725
Correction Factor		0.63	0.71	0.78	0.84	0.90	0.95	1.00

Accessories Weld Flange Connection Kits to connect up to 3 filters in series

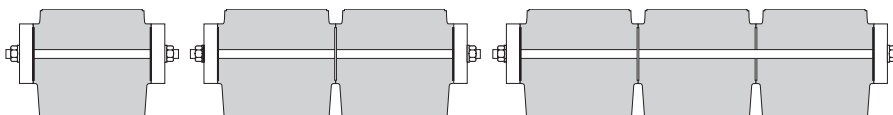

Model	1 Stage	UNIT PRICE \$	2 Stage	UNIT PRICE \$	3 Stage	UNIT PRICE \$
0030G	MFK1-1	P.O.A.	MFK1-2	P.O.A.	MFK1-3	P.O.A.
0045G	MFK2-1	P.O.A.	MFK2-2	P.O.A.	MFK2-3	P.O.A.
0095G	MFK3-1	P.O.A.	MFK3-2	P.O.A.	MFK3-3	P.O.A.
0145G	MFK4-1	P.O.A.	MFK4-2	P.O.A.	MFK4-3	P.O.A.
0285G	MFK5-1	P.O.A.	MFK5-2	P.O.A.	MFK5-3	P.O.A.
0465G	MFK6-1	P.O.A.	MFK6-2	P.O.A.	MFK6-3	P.O.A.
0965G	MFK7-1	P.O.A.	MFK7-2	P.O.A.	MFK7-3	P.O.A.

OIL-Xplus Stainless Steel Compressed air filters



Technical data

Maximum operating pressure:	16 bar g (232 psi g)
Maximum recommended operating temperature:	66°C Grade AO, AA, AR, AAR 30°C Grade ACS
Minimum recommended operating temperature:	1.5°C

Initial 'dry' differential pressure:	70 mbar (1.0 psi) Grade AO, AR 100 mbar (1.5 psi) Grade AA, AAR 200 mbar (3.0 psi) Grade ACS
Initial 'wet' differential pressure:	140 mbar (2.0 psi) Grade AO 200 mbar 3.0 psi) Grade AA Grade ACS, AR N/A

Housing constructed from Stainless Steel : Grade 316L

Filter Type	Port Size	Flow Rates*			UNIT PRICE \$
		m³/min	m³/hr	cfm	
(grade) 0009GSS	G1/4	0.53	32	19	P.O.A.
(grade) 0017GSS	G3/8	1.02	61	36	P.O.A.
(grade) 0030GSS	G1/2	1.80	108	64	P.O.A.
(grade) 0058GSS	G3/4	3.60	216	127	P.O.A.
(grade) 0080GSS	G1	4.80	288	170	P.O.A.
(grade) 0145GSS	G1 1/2	8.70	522	307	P.O.A.
(grade) 0220GSS	G2	13	792	466	P.O.A.
(grade) 0330GSS	G2	20	1188	699	P.O.A.
(grade) 0405GSS	G2 1/2	24	1440	848	P.O.A.
(grade) 0430GSS	G3	26	1548	911	P.O.A.

Replacement Element Kit	No	UNIT PRICE \$
K009 (grade)	1	113.00
K017 (grade)	1	179.00
K030 (grade)	1	208.00
K058 (grade)	1	258.00
K145 (grade)	1	340.00
K145 (grade)	1	340.00
K220 (grade)	1	403.00
K330 (grade)	1	579.00
K430 (grade)	1	679.00
K430 (grade)	1	679.00

*Stated flows are for operation at 7 bar(g) (102 psi(g)) with reference to 20°C, 1 bar (a), 0% relative water vapour pressure.

Filtration grades

GRADE AO

High Efficiency General Purpose Protection
Particle removal down to : 1 micron, including water and oil aerosols. Maximum remaining oil aerosol content: 0.6 mg/m³ at 21°C.

GRADE AA

High Efficiency Oil Removal Filtration
[Precede with Grade AO filter]
Particle removal down to: 0.01 micron, including water and oil aerosols. Maximum remaining oil aerosol content: 0.01 mg/m³ at 21°C.

GRADE ACS

Oil Vapour & Odour Removal
[Precede Grade ACS with Grade AA filter]
Maximum remaining oil vapour content: 0.003 mg/m³ at 21°C.

GRADE AR

General Purpose Dust Filtration
Dry Particle removal down to : 1 micron

GRADE AAR

High Efficiency Dust Filtration
Dry Particle removal down to : 0.01 micron

Filter Type	Dimensions mm					Weight Kg
	A	B	C	D	E	
(grade) 0009GSS	145	50.5	210	246	80	2.5
(grade) 0017GSS	145	50.5	236	272	100	2.5
(grade) 0030GSS	154	50.5	270	306	130	2.5
(grade) 0058GSS	190	86	382	431	175	4.5
(grade) 0080GSS	200	86	506	555	275	5.0
(grade) 0145GSS	225	86	506	555	275	5.0
(grade) 0220GSS	280	102	628	677	350	10.0
(grade) 0330GSS	280	102	938	987	650	12.0
(grade) 0405GSS	290	102	698	747	430	12.0
(grade) 0430GSS	300	102	698	747	430	12.0

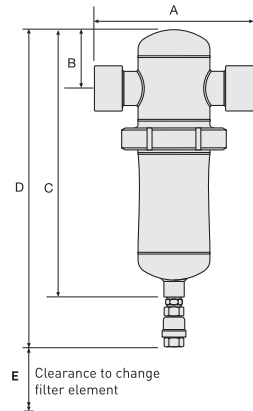

Flow correction factors

Line Pressure	bar g	1	2	3	4	5	6	7	8	9	10	11	12	13	14	15	16
	psi g	15	29	44	58	73	87	100	116	131	145	160	174	189	203	218	232
Correction Factor		0.38	0.53	0.65	0.76	0.85	0.93	1.00	1.07	1.13	1.19	1.25	1.31	1.36	1.41	1.46	1.51

To find the correction factors for pressures other than 7 bar g (100 psi g), use the following equation

e.g. Correction factor = $\sqrt{\frac{\text{System Operating Pressure}}{\text{(Nominal pressure)}}}$ = $\sqrt{\frac{8.5 \text{ bar g}}{7 \text{ bar g}}}$ = 1.10 Therefore, for 8.5 bar g multiply nominal flow rate by 1.10

NOTES

1. Manual drain valves are supplied as standard.

Food Grade Compressed Air



A new code of practice covering the use of compressed air in the food industry has been developed between the British Retail Consortium and the British Compressed Air Society. The code gives minimum quality standards for compressed air and defines allowable levels for dirt, water and total oil in line with quality levels specified in ISO8573.1 the international standard for compressed air quality.

Quality Levels

Section 6 of the code of practice provides air quality standards for compressed air that is either in direct contact with food (specified in section 6.1 as contact) or air that could come in contact with food (specified in section 6.1 as non-contact).

Air Quality Recommendation	Dirt (Solid Particulate) Max Number of Particles per m ³			Humidity (Water Vapour)	Total Oil (Aerosol + Vapour)	ISO8573.1 Equivalent
	0.1-0.5 micron	0.5 - 1 micron	1 - 5 micron			
Contact	100,000	1,000	10	-40°C PDP	< 0.01 mg/m ³	Class 2.2.1
Non - Contact	100,000	1,000	10	+3°C PDP	≤ 0.01 mg/m ³	Class 2.4.1
Non - Contact High Risk	100,000	1,000	10	-40°C PDP	≤ 0.01 mg/m ³	Class 2.2.1

Reference Conditions from ISO8573.1 : Absolute atmospheric pressure 1 bar, Temperature = 20°C.
Humidity is measured at air line pressure.

In addition, section 6.2 gives advice on assessing microbiological contamination.

Lubricants

Section 5.4.4a of the Code of Practice states 'Where lubricated or oil-injected compressors are in use and non-food grade oil is used and the HACCP process identifies a risk, then the oil shall be replaced with food grade oils in line with the procedures identified in the EHEDG Document 23.'

A Guaranteed Solution to Food Grade Compressed Air

Compressed Air and its purification

General Systems

It is often believed that the compressed air purification equipment required is dependent upon the type of compressor used. In fact, the contamination in a compressed air system (dirt, water and oil) comes from many sources such as, the ambient air, compressor lubricants, corrosion of the distribution piping and microbiological growth in the warm, moist air.

A common misconception is that by installing an 'oil free' compressor there is no need for downstream filtration. However the term 'oil free' simply means that oil is not used in the compression chamber and therefore does not come into contact with the air being compressed. Even with an oil-free compressor, filtration will be required to remove dirt, condensed water & oil vapour drawn into the compressor intake as well as dirt present from the distribution system.

Coalescing Filters

Aerosols (droplets) of oil & water are removed using coalescing type filters which have the additional benefit of removing solid particulate to very low levels (as small as 0.01micron in size). In a typical oil lubricated compressed air system, up to 99.5% of the liquid removed by coalescing filters is water.

Adsorption Filters

Oil vapour will pass through the coalescing filter just as easily as the compressed air itself. Oil Vapour Removal (OVR) filters provide a large bed of activated carbon adsorbent for the removal of oil vapours and provide final protection against oil contamination.

Refrigeration Dryers

CRD Refrigeration dryers provide water vapour removal with a pressure dewpoint of +3°C. Ideal for general purpose compressed air and air not in direct contact with food.

Adsorption Dryers

PNEUDRI adsorption dryers provide water vapour removal with a pressure dewpoint of -40°C (-70°C optional). A compressed air dewpoint of less than -26°C will inhibit the growth of micro-organisms within the compressed air system.

Microbiological Filters

Where HACCP has established a risk, specific filtration is available to provide sterile compressed air. Steam sterilisable High Flow Tetpor filters provide absolute removal of micro-organisms.

Food Grade Compressed Air

Compressed Air and Gas Sampling



In ultra-clean and critical compressed air applications, such as those required in the food and beverage or pharmaceutical industries, unwanted micro-biological contamination could have severe consequences on the process. Any remaining micro-organisms will in normal conditions, multiply exponentially, and even a few will lead to diminished product quality, reduced shelf life and ultimately cause complete and costly batch spoilage. Quite often, the presence of micro-biological contamination is discovered only when it is too late.

Regular testing by our technicians utilising widely accepted high quality instruments will identify contamination and allow corrective action to be taken prior to product spoilage. This is offered as a specific service or to run concurrently with any individual specific testing requirements such as those in the food and beverage industry. In all cases our technicians can provide innovative solutions to specific problem areas.

Parker Filtration recommends that regular analysis of your compressed air and gas system as part of a complete air quality program will increase long term system efficiency and will reduce costs. All of our technicians are qualified to carry out the following in line with the food grade code of practice:

- Air quality testing
- Ultrasonic air and gas leak detection
- Particle counting
- Pressure and temperature testing

This state of the art test uses samplers based on slit to agar impaction. The units sample air or compressed gas for the presence and enumeration of viable micro-organisms. These samplers operate by drawing in air or gas at a fixed flow rate. A volume of 1 cubic metre is sampled during a calibrated period (typically 1 hour). The air or gas accelerates to a sufficiently high velocity to give maximum validated recovery of impacted organisms on the agar surface during this period of time.

After appropriate incubation, the growth on the plated medium can be interpreted not only quantitatively but also from a real time occurrence of contamination. This can prove invaluable in pinpointing which event during a manufacturing process has raised the environmental bio-burden above acceptable limits. Once identified these areas can be scrutinised and appropriately addressed.

Benefits of Slit to Agar Impaction

- Tried and tested technology
- Effective capture method with a validated rate of recovery
- Pinpoint isolation timing
- Reduced risk of double impingement



Food Grade Compressed Air

System Design

To achieve the stringent air quality levels required for food manufacture, a careful approach to system design, commissioning and operation must be employed. It is highly recommended that the compressed air is treated prior to entry into the distribution system as well as at each usage point or application. This approach to system design provides the most cost effective solutions to food grade compressed air as shown in the examples below.

CONTACT

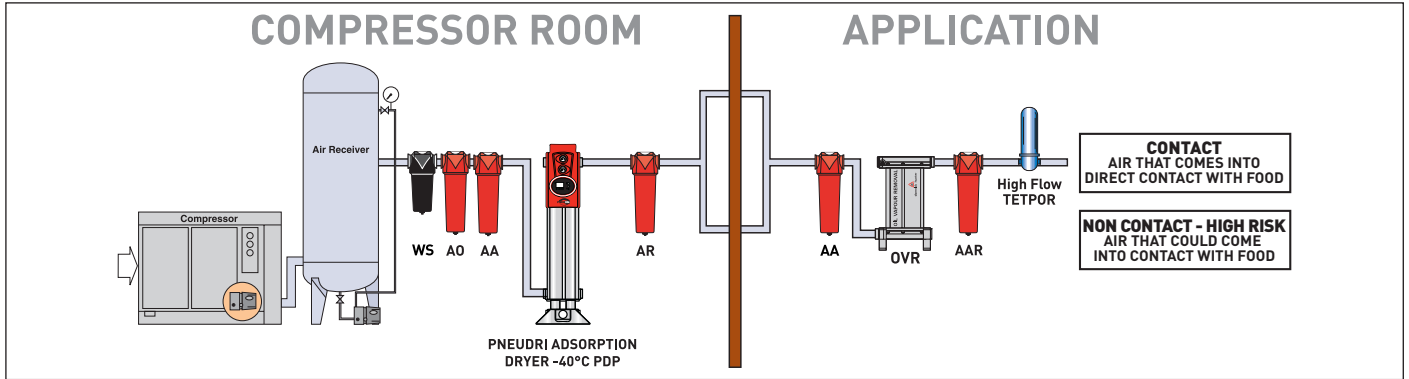

NON-CONTACT

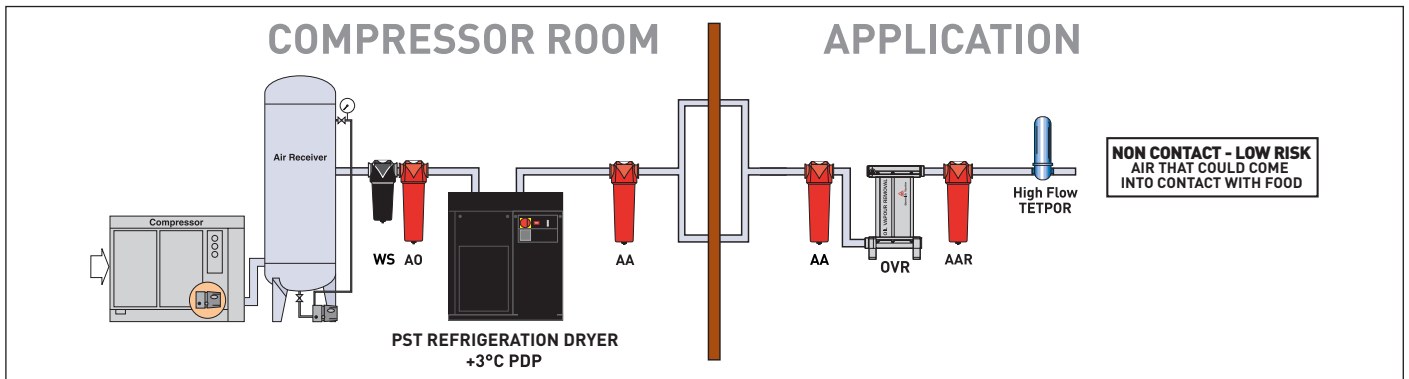

NON-CONTACT

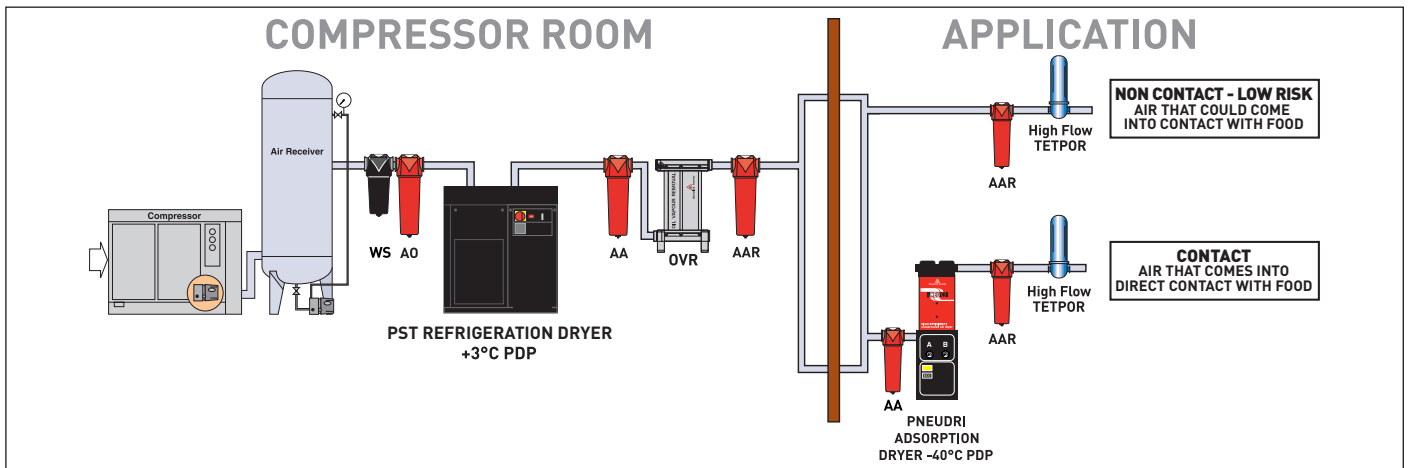

Air Quality Recommendation	Dirt (Solid Particulate)	Humidity (Water Vapour)	Total Oil (Aerosol & Vapour)
Contact	OIL-X EVOLUTION GRADE AO + AA	PNEUDRI -40°C PDP	OIL-X EVOLUTION GRADE AO + AA + OVR
Non - Contact Low Risk	or	CRD +3°C PDP	
Non - Contact High Risk	OIL-X EVOLUTION GRADE AR + AAR For dry particulate*	PNEUDRI -40°C PDP	

KEY:
 WS - BULK LIQUID REMOVAL / OIL-X EVOLUTION Grade AO - GENERAL PURPOSE COALESCING FILTER / OIL-X EVOLUTION Grade AA - HIGH EFFICIENCY COALESCING FILTER
 OIL-X EVOLUTION Grade AR - GENERAL PURPOSE DUST REMOVAL FILTER / OIL-X EVOLUTION Grade AAR - HIGH EFFICIENCY DUST REMOVAL FILTER /
 OVR - OIL VAPOUR REMOVAL FILTER / HIGH FLOW TETPOR - Optional Sterile Air Filter

Food Grade Compressed Air

Guaranteed Air Quality

All air treatment products are supplied with a one year compressed air quality guarantee, when sized, installed and maintained in accordance with Parker Filtration recommendations.

Measurement and Testing

Section 7 of the code of practice requires systems to be tested twice per year by qualified personnel with specialised equipment. As a full customer service organisation, Parker Filtration can carry out a complete compressed air system health check and provide a full range of cost effective, tailored maintenance programmes which will satisfy the testing requirements of the code.

Compressed Air Health Check

For a complete system health check and details of maintenance programmes available, contact Parker Filtration or a recognised Parker Filtration distributor.



Sterile Air / ISO 8573.1:2001

Class 1 Particulate removal



HIGH FLOW TETPOR II MEMBRANE FILTERS

Food and beverage sterile air / particulate free filtration

Full retention of bacteria, viruses and particulate. Based on membrane technology. Retention correlated to a liquid bacterial challenge (ASTM 838-38) as well as bacterial and viral aerosol challenge. Used for the most critical of applications including medical, pharmaceutical / aseptic packaging and electronics.

Filter housing and filter element are supplied as separately priced items and must be ordered separately

Filter Type	Port Size	*Flowrate @ 7 bar g (100 psi g) 20°C (68°F) initial Δp 100 mbar (1.4 psi)			Dimensions mm		Approx. Weight Kg	UNIT PRICE \$	Element Code	UNIT PRICE \$
		m³/min	m³/hr	cfm	A	B				
HBACE-01BQB-T-S-BB-B-X	½"	0.6	34	20	245	132	1.4	1659.00	ZHFT/BT/1	299.00
HBACE-01BXB-T-S-BB-B-X	¾"	0.8	51	30	245	147	1.4	1659.00	ZHFT/BT/1	299.00
HBACE-01BAB-T-S-BB-B-X	½"	1.2	71	42	245	157	1.4	1659.00	ZHFT/BT/1	299.00
HBACE-01ATB-T-S-BB-B-X	¾"	1.7	102	60	300	160	1.5	1923.00	ZHFT/AT/1	361.00
HBACE-01ABB-T-S-BB-B-X	1"	2.5	153	90	300	175	1.5	1923.00	ZHFT/AT/1	361.00
HBACE-01KYB-T-S-BB-B-X	1½"	3.4	204	120	397	231	4.4	2171.00	ZHFT/KC	490.00
HBACE-011CB-T-S-BB-B-X	1½"	4.0	238	140	547	256	5.0	2418.00	ZHFT/1C	966.00
HBACE-012CB-T-S-BB-B-X	2"	6.8	408	240	797	256	6.0	2506.00	ZHFT/2C	1912.00

*Selection - The above filter types have BSPP connections, alternative pipe connections are available as detailed below, please consult your Parker Filtration distributor for selection and additional costs.

Filter housing

- Highly polished crevice free stainless steel

Maximum operating pressure:	10 bar g
Maximum operating temperature:	150°C

Filter element

- Pleated High Flow TETPOR II filter cartridge (0.01 micron)

Maximum continuous operating temperature:	60°C
Maximum steam sterilisation temperature:	142°C
Steam life:	225 cycles @ 142°C (288°F)

Code	Inlet/Outlet Connections
N	NPT Female
T	Tri-Clamp
A	Weld Prepared
F	ANSIRF 150

Flow correction factors

Line	bar g	1	2	3	4	5	6	7	8	9	10	11	12	13	14	15	16
Pressure	psi g	15	29	44	58	73	87	100	116	131	145	160	174	189	203	218	232
Correction Factor		0.4	0.5	0.65	0.75	0.85	0.95	1	1.15	1.25	1.40	1.50	1.6	1.75	1.90	2.00	2.15

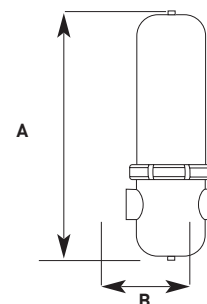

* Dimensions are for housings with weld prepared connections.

ES2000 Series

Oil/Water Separators



Technical data

Model	Hose Connection ID		Settlement tank capacity	Max. Pressure		Min/Max Temperature °C	Weight Kg		UNIT PRICE \$
	Inlet	Outlet		bar g	psi g		Empty	Full	
ES2100/TI	1 x 1/2" - 1 x 1/4"	19mm (3/4")	N/A	16	232	5 - 35	6	24.5	769.00
ES2150/TI	1 x 1/2" - 1 x 1/4"	25mm (1")	60 L	16	232	5 - 35	10	78.5	1409.00
ES2200/TI	1 x 1/2" - 1 x 1/4"	19mm (3/4")	75 L	16	232	5 - 35	12	93.5	1658.00
ES2300/TI	1 x 1/2" - 3 x 1/4"	25mm (1")	125 L	16	232	5 - 35	27	159	2430.00
ES2400/TI	1 x 1/2" - 3 x 1/4"	25mm (1")	185 L	16	232	5 - 35	36	217	2891.00
ES2500/TI	1 x 1/2" - 3 x 1/4"	25mm (1")	335 L	16	232	5 - 35	70	400	3638.00
ES2600/TI	1 x 1/2" - 3 x 1/4"	25mm (1")	485 L	16	232	5 - 35	97	550	5345.00

Product selector

All Parker Filtration condensate drains & oil/water separators are sized based upon the maximum condensate volume produced at a given set of ambient conditions. Should the conditions differ from those shown below, please contact UK Industrial Sales for correct model selection.

Ambient Temperature at Compressor Inlet:	25°C	System Pressure:	7 bar g (102psi g)
Relative Humidity:	65%	Refrigeration Dryer Dewpoint:	2°C
Compressor Discharge Temperature:	35°C		

No Refrigeration dryer installed in system		OIL TYPE								
		Band A Turbine, Additive			Band B Mineral, PAO, TMP, PE			Band C Diesters, Triesters, PAG		
Compressor Type	Model	m³/min	m³/hr	cfm	m³/min	m³/hr	cfm	m³/min	m³/hr	cfm
	ES2100/TI	1.2	74	43	1.0	62	36	0.9	51	30
	ES2150/TI	3.5	211	124	3.0	179	106	2.4	146	86
	ES2200/TI	5.4	325	191	4.6	276	162	3.7	224	132
Rotary Screw, Vane	ES2300/TI	7.6	456	268	6.4	383	225	5.2	314	185
	ES2400/TI	15.1	909	535	12.7	764	450	10.5	628	370
	ES2500/TI	30.1	1804	1062	25.5	1530	900	20.8	1247	734
	ES2600/TI	59.8	3590	2113	51.0	3057	1800	41.4	2482	1461

Refrigeration dryer installed in system		OIL TYPE								
		Band A Turbine, Additive			Band B Mineral, PAO, TMP, PE			Band C Diesters, Triesters, PAG		
Compressor Type	Model	m³/min	m³/hr	cfm	m³/min	m³/hr	cfm	m³/min	m³/hr	cfm
	ES2100/TI	0.9	55	33	0.8	46	27	0.6	38	22
	ES2150/TI	2.6	158	93	2.2	134	79	1.8	109	64
	ES2200/TI	4.1	243	143	3.4	207	122	2.8	168	99
Rotary Screw, Vane	ES2300/TI	5.7	341	201	4.8	286	169	3.9	235	138
	ES2400/TI	11.3	680	400	9.5	572	337	7.8	470	277
	ES2500/TI	22.5	1351	795	19.1	1145	674	15.6	934	549
	ES2600/TI	44.8	2687	1582	38.1	2288	1347	31.0	1858	1093

IMPORTANT NOTE

The performance of the oil/water separator and the economic service life of the activated carbon is dependent upon the degree of oil dispersion and emulsification of the incoming condensate. The frequency of activated carbon pack changes will therefore depend upon the following factors.
Compressor type and capacity, lubricant used, condensate drainage method, ambient temperature, relative humidity, pressure and condensate drainage method.
Static oil/water separators of this type will not totally separate oils that are soluble in water.

Model	Replacement Carbon Pack	UNIT PRICE \$	Quantity Required	TOTAL PRICE \$
ES2100 & ES2100/TI	ESMK1	291.00	1	291.00
ES2150 & ES2150/TI	ESMK1	291.00	1	291.00
ES2200 & ES2200/TI	ESMK1	291.00	1	291.00
ES2300 & ES2300/TI	ESMK2	291.00	1	291.00
ES2400 & ES2400/TI	ESMK2	291.00	2	582.00
ES2500 & ES2500/TI	ESMK3	590.00	1	590.00
ES2600 & ES2600/TI	ESMK3	590.00	2	1180.00

Vent Filter	UNIT PRICE \$	Additional Oil Container	UNIT PRICE \$
ESVF1	31.00	N/A	-
ESVF1	31.00	OC1	102.00
ESVF1	31.00	OC1	102.00
ESVF2	48.00	OC2	120.00
ESVF2	48.00	OC2	120.00
ESVF2	48.00	OC2	120.00
ESVF2	48.00	OC2	120.00

Oil / Water Separator maintenance kits



Replacement carbon bag kits for previous Parker Filtration ranges

To Suit Separator Models	Quantity Required	Maintenance kits	UNIT PRICE \$	TOTAL PRICE \$
ES2100 & ES2100/TI	1	ESMK1	291.00	291.00
ES2150 & ES2150/TI				
ES2200 & ES2200/TI				
ES36				
ES90				
SE2010	1	ESMK2	291.00	291.00
SE2015				
ES2300 & ES2300/TI	2	ESMK2	291.00	582.00
ES125				
ES2400 & ES2400/TI	1	ESMK3	590.00	590.00
ES250				
SE2030/SE2030P	2	ESMK3	590.00	1180.00
ES2500 & ES2500/TI				
ES500				
ES2600 & ES2600/TI	2	ESMK3	590.00	1180.00
ES1000				

Each ESMK kit consists of an activated carbon bag and adsorbent pre-filter.

UPGRADE

your Oil/Water Separator to a Parker Filtration ES2000 Series to assist with meeting ISO 14001

Call 1300 307 497 and ask for Industrial Sales and Service for more details or email dh.Australia@parker.com

Alternative maintenance kits

Donaldson Ultrafilter

To Suit Separator Models	Quantity Required	Maintenance kits	UNIT PRICE \$
UF-SP7.5	1	KMU-SP7.5	226.00
UF-SP10	1	KMU-SP10	247.00
UF-SP15	1	KMU-SP15	314.00
UF-SP30	1	KMU-SP30	417.00
UF-SP60	1	KMU-SP60	782.00
UF-SP120	1	KMU-SP120	1431.00
UF-SP240	1	KMU-SP240	2862.00
UFS-7.5	1	KMU-1075	210.00
UFS-15	1	KMU-1015	314.00
UFS-30	1	KMU-1030	404.00
UFS-60	1	KMU-1060	759.00
UFS-120	1	KMU-1120	1348.00
UFS-240	1	KMU-1240	2862.00

Zander

To Suit Separator Models	Quantity Required	Maintenance kits	UNIT PRICE \$
ES2	1	KMZ-1002	222.00
ES3	1	KMZ-1003	291.00
ES4	1	KMZ-1004	291.00
ES8	1	KMZ-1008	291.00
ES15	1	KMZ-1015	291.00
ES30	1	KMZ-1030	625.00
ES60	1	KMZ-1060	1199.00
WT 1	1	KMZW-1001	232.00
WT 2	1	KMZW-1002	305.00
WT 3	1	KMZW-1003	608.00
WT 10	1	KMZW-1010	232.00
WT 20	1	KMZW-1020	426.00
WT 30	1	KMZW-1030	709.00
ESVEN	1	KMZ-VEN	278.00

Beko

To Suit Separator Models	Quantity Required	Maintenance kits	UNIT PRICE \$
Owamat 1	1	KMB-1001	199.00
Owamat 2	1	KMB-1002	199.00
Owamat 3	1	KMB-1003	370.00
Owamat 4	1	KMB-1004	441.00
Owamat 5	1	KMB-1005	658.00
Owamat 6	1	KMB-1006	973.00
Owamat 8	1	KMB-1008	2079.00

ED3000 Series

Level sensing condensate drains



Features and Advantages

The Ecodrain ED3000 series feature:

Non-wearing magnetic-core level control for optimum and "air-loss free" discharge of condensate.

Integrated dirt screen between level measurement and drain valve to protect the diaphragm valve with alarm monitoring.

A diaphragm valve with large cross-section and condensate pilot control for extended service life.

Voltage-free alarm contact (except ED3002, ED3004)

Non-wearing magnetic-core level control: The magnetic-core level control employs reed-switching points to operate the valve. Non-contact magnetic sensors detect the magnetic core signal transmitter position.

The collecting vessel integrated in the condensate drain is always used at optimum efficiency. This results in a minimised number of switching cycles and thus, maximum service life of the drain valve. No calibration required!

Integrated dirt screen: The dirt screen is integrated between the level control and the drain valve. Retains any contaminants that could damage the diaphragm valve that triggers an alarm, also if the screen is clogged by dirt.

Allows the drain to be cleaned easily and rapidly:

Model	Voltage AC	Frequency Hz	Volt Free Contacts	Connections		Operating Pressures		Operating Temp		Unit Price \$
				Inlet	Outlet	Max	Min	Max	Min	
ED 3002	230V	50/60	optional	1 x G 3/8	G 1/8	16 bar g	4 bar g	66°C	2°C	305.00
ED 3004	230V	50/60	optional	1 x G 1/2	G 1/8	16 bar g	4 bar g	66°C	2°C	329.00
ED 3007	230V	50/60	yes	2 x G 1/2	G 1/8	16 bar g	4 bar g	66°C	2°C	548.00
ED 3030	230V	50/60	yes	2 x G 1/2	G 1/8	16 bar g	4 bar g	66°C	2°C	768.00
ED 3100	230V	50/60	yes	2 x G 1/2	G 1/8	16 bar g	4 bar g	66°C	2°C	877.00

ED3002 for use with filters only

1. For simple connection to domnick hunter products, please use adaptor kits.
2. Models shown above have BSP connections, NPT connections also available.
3. A strainer is recommended for condensate contaminated with particulate

Technical Data

All domnick hunter condensate drains & oil / water separators are sized based upon the maximum condensate volume produced at a given set of ambient conditions. Should the conditions differ from those shown below, please contact domnick hunter Technical Sales Department for correct model selection.

Ambient Temperature at compressor inlet: 25°C (77°F)

Relative humidity at compressor inlet: 60%

Compressor discharge temperature: 35°C (95°F)

System pressure: 7 bar g (100 psi g)

Refrigerant dryer dewpoint: 3°C

Compressor / Air Receiver Flow Rates			
Model	Nm ³ /min	Nm ³ /hr	scfm
ED 3002	N/A	N/A	N/A
ED 3004	4	240	142
ED 3007	7	420	248
ED 3030	30	1800	1059
ED 3100	100	6000	3530

ED3002 for use with filters only

Refrigeration Dryer Flow Rates			
Model	Nm ³ /min	Nm ³ /hr	scfm
ED 3002	N/A	N/A	N/A
ED 3004	8	480	283
ED 3007	14	840	495
ED 3030	60	3600	2118
ED 3100	200	12000	7059



ED3000 Adaptor Kits		Unit Price \$
Kit	For Drain	
MK M14-G38i	ED3002	112.00
MK M14-G12	ED3004-ED3100	134.00

Maintenance Kit ED3000 Series	Unit Price \$
SK ED3000	111.00

OIL-X EVOLUTION Filter and WS Water Separator Selection

ED3002 suitable for OIL-X EVOLUTION models 010ABFX - 060KBFX and WS models WS010-030.

HIROSS Aftercoolers

Cooling compressed air



"THE HEART OF A COMPRESSED AIR NETWORK."

When contemplating a quality Compressed Air Treatment system, the after cooler is often overlooked. Which is a surprise, as typically the after cooler removes over 80% of the condensate within the system. Being installed straight after the Air Compressor, the after cooler is subjected to significantly higher levels of moisture than other components downstream. Furthermore, as they are installed before any filtration stages after coolers are subjected to extreme operating conditions, which must be overcome to ensure optimum operation. An undersized or incorrectly operating after cooler will compromise the whole compressed air station: the consequences are increased maintenance; higher operating costs and damaged finished goods. Furthermore, a generously dimensioned after cooler allows the installation of smaller Refrigeration and Adsorption Dryers, offering savings in capital investment and energy consumption.

MODEL	AIR FLOW		Air CONN.	Max Press (bar g)	DIMENSIONS (mm)						WEIGHT (KG)	
	m ³ /min	cfm.			A	B	C	D	E	F		
AIR COOLED MODELS												
											COOLER ONLY	
ANS000	0.6	21	3/4"	16	360	794	216	457	522	476	7.5	P.O.A.
ANS001 AASY	1.2	42	3/4"	16	430	895	277	545	522	476	11	1272.00
ANS003 ASSY	2.5	88	1 1/2"	16	550	1140	403	715	657	567	22	2084.00
ANS 004 ASSY	3.5	124	1 1/2"	16	550	1140	403	715	657	567	28	2220.00
ANT006 ASSY	6	212	1 1/2"	16	610	1336	453	775	753	663	30	3595.00
ANT009	9	318	2"	16	702	1361	445	908	751	694	41	P.O.A.
ANT014	14	494	2"	16	890	1523	500	1075	815	756	75	P.O.A.
ANT018	18	636	DN 80	12	1114	1857	560	1516	892	892	85	P.O.A.
ANT028	28	989	DN 100	12	1418	1807	560	1820	892	892	134	P.O.A.
ANT036	36	1271	DN 100	12	1518	2075	580	1980	960	960	190	P.O.A.
ANT040	40	1412	DN 150	9	1424	1983	1013	1980	1780	1080	323	P.O.A.
ANT048	48	1695	DN 150	9	1550	1983	1013	3102	1730	1130	478	P.O.A.
ANT064	64	2260	DN 200	9	1550	1983	1040	3122	1730	1130	494	P.O.A.
ANT075	75	2649	DN 200	9	2550	1983	1040	3122	1730	1130	514	P.O.A.

ANS are single-phase models and ANT are 3-phase models.

ANS/T 000-014

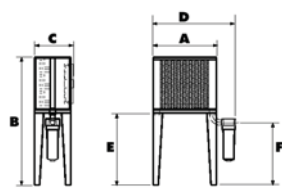

ANT 018-036

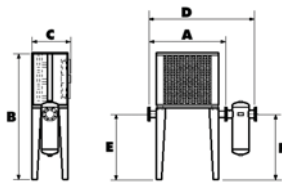

ANT 040-075

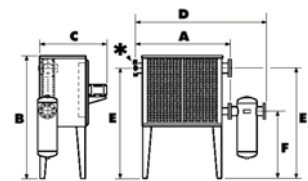

* For 040: Air inlet is on opposite side to air outlet.
For 048-075: Air inlet and outlet are both on the Separator side.

Air-cooled models

Hot compressed air passes through the after cooler tubes. Ambient cooling air is forced across these tubes by the fan, with fins on the tubes increasing the cooling efficiency. The air is cooled to a temperature, which can be as little as 5°C above the ambient temperature. As the compressed air cools, so liquid condensate is created; an optional centrifugal separator installed at the after cooler outlet efficiently removes this.

Water-cooled models

Hot compressed air passes through the after cooler tubes. Cooling water passes around the tubes in counter flow, the internal baffles forcing it to make several passes for increased efficiency. The air is cooled to a temperature, which can be as little as 5°C above the cooling water inlet temperature. As the compressed air cools, so liquid condensate is created; an optional centrifugal separator installed at the after cooler outlet efficiently removes this.

MODEL	AIR FLOW		CONNECTIONS		Max Press (bar g)
	m ³ /min	cfm.	AIR	WATER	
WATER-COOLED MODELS WITH REMOVABLE TUBE-BUNDLE					
WRN003	3	106	1 1/2"	1/2"	16
WRN007	7	247	1 1/2"	1/2"	16
WRN011	11	388	2"	3/4"	16
WRN016	16	565	2"	3/4"	16
WRN022	22	77	DN 100	1"	12
WRN028	28	989	DN 100	1"	12
WRN038	38	1342	DN 125	1 1/4"	12
WRN050	50	1766	DN 125	1 1/4"	12
WRN060	60	2119	DN 150	1 1/4"	12
WRN090	90	3178	DN 200	1 1/4"	12
WRN130	130	4591	DN 250	1 1/2"	10
WRN170	170	6003	DN 300	2"	10
WRN200	200	7063	DN 350	2"	10

PRICE ON APPLICATION

MODEL	AIR FLOW		CONNECTIONS		Max Press (bar g)
	m ³ /min	cfm.	AIR	WATER	
WATER-COOLED MODELS WITH FIXED TUBE-BUNDLE					
WFN002	1.2	42	3/4"	3/8"	16
WFN004	3.5	124	1 1/2"	1/2"	16
WFN007	6.5	230	1 1/2"	3/4"	16
WFN009	9	318	2"	3/4"	16
WFN013	13	459	2"	3/4"	16
WFN018	18	636	DN 80	1"	12
WFN027	27	953	DN 100	1 1/4"	12
WFN036	36	1271	DN 100	1 1/4"	12
WFN050	50	1766	DN 125	1 1/4"	12
WFN060	60	2119	DN 150	1 1/4"	12
WFN090	90	3178	DN 200	1 1/4"	12

Performances refer to models with standard materials operating with clean Cooler conditions with air at FAD 20°C/1 bar A, and at the following working conditions: air suction 25°C/60%RH, 7 bar g working pressure, 120°C compressed air inlet temperature, temperature approach between air outlet and water (water-cooled models) or cooling air (air-cooled models) inlet of ca. 10°C. Performance for models with non-standard materials may differ from those above. Power supply for air-cooled models: ANS are single-phase, ANT are 3-phase. For models with matching separator, air outlet may differ from above.

SPL Refrigeration dryers

0.2 - 6.0 m³/min (7 - 212 cfm) ISO 7183 50Hz



Technical data

Maximum ambient temperature	50°C
Maximum inlet temperature	65°C
Minimum ambient temperature	5°C
Maximum pressure	16 bar g
Electrical supply	230V 1ph 50hz
Refrigerant:	R134a

* Flow capacities in accordance with ISO8573, air suction of FAD 20°C, 1 bar (14.5psi) at the following operating conditions:

Ambient temperature:	25°C
Inlet temperature:	35°C Relative humidity 60%
Working pressure:	7bar g (102psi g),
Dewpoint:	3°C

Model	Pipe Size	Nominal Flow 3°C Dewpoint			Nominal Absorbed Power		UNIT PRICE \$
		m ³ /min	m ³ /hr	cfm	kW	hp	
SPL004	½" BSP	0.4	24	14	0.13	0.17	1316.00
SPL006	½" BSP	0.6	36	21	0.17	0.23	1397.00
SPL009	½" BSP	0.9	54	32	0.25	0.34	1652.00
SPL012	½" BSP	1.2	72	43	0.25	0.34	1947.00
SPL018	¾" BSP	1.8	108	64	0.49	0.66	2359.00
SPL024	¾" BSP	2.4	144	85	0.57	0.76	2817.00
SPL030	¾" BSP	3	180	106	0.78	1.05	3203.00
SPL040	1½" BSP	4	240	141	0.71	0.95	4019.00
SPL050	1½" BSP	5	300	177	0.85	1.14	4726.00
SPL060	1½" BSP	6	360	212	1.05	1.41	5403.00

Weights and dimensions

Model	Dimensions mm			Weight Kg
	A	B	C	
SPL004	210	430	450	19
SPL006	210	430	450	19
SPL009	210	505	500	23.5
SPL012	210	505	500	23.5
SPL018	225	565	520	26.5
SPL024	225	565	520	31
SPL030	225	565	520	35
SPL040	425	600	555	52
SPL050	425	600	555	58
SPL060	425	600	555	60

Recommended Filtration			
General Purpose Pre-Filter	UNIT PRICE \$	High Efficiency Outlet Filter	UNIT PRICE \$
A0010CBFX	387.00	AA010CBFX	387.00
A0010CBFX	387.00	AA010CBFX	387.00
A0015CBFX	482.00	AA015CBFX	482.00
A0015CBFX	482.00	AA015CBFX	482.00
A0020DBFX	536.00	AA020DBFX	536.00
A0025DBFX	911.00	AA025DBFX	911.00
A0025DBFX	911.00	AA025DBFX	911.00
A0030GBFX	1020.00	AA030GBFX	1020.00
A0030GBFX	1020.00	AA030GBFX	1020.00
A0030GBFX	1020.00	AA030GBFX	1020.00

Flow correction factors

Capacity correction factors to be used when operating conditions differ from those shown above. To obtain dryer capacity at new conditions multiply nominal capacity* x C1 x C2 x C3 x C4

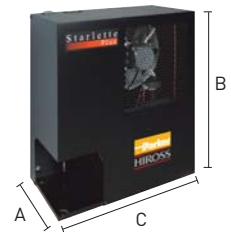

Ambient Temperature (C1)

°C	20	25	30	35	40	45	50
Correction Factor	1.05	1.00	0.94	0.88	0.81	0.75	0.68

Inlet Temperature (C2)

°C	30	35	40	45	50	55	60	65
Correction Factor	1.22	1.00	0.83	0.69	0.58	0.49	0.46	0.43

Inlet Pressure (C3)

Pressure bar g	3	4	5	6	7	8	9	10	11	12	13	14	15	16
Pressure psi g	44	58	73	87	100	116	131	145	160	174	189	203	218	232
Correction Factor	0.73	0.83	0.90	0.95	1.00	1.03	1.07	1.09	1.12	1.13	1.15	1.17	1.18	1.19

Dewpoint (C4)

°C	3	5	7	10
Correction Factor	1.00	1.12	1.24	1.46

PST Refrigeration dryers

4 - 180 m³/min (141 - 7688 cfm)

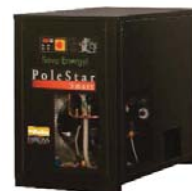

Product Selection & Technical Data

Model	Pipe Size	Nominal Flow 3°C Dewpoint			Electrical Supply 50Hz		Nominal Absorbed Power at 3°C Dewpoint		UNIT PRICE \$
		m ³ /min	m ³ /hr	cfm	230V / 1ph	400V / 3ph + N	kW	hp	
PST075	1½"	7.6	455	265	•		1.08	1.45	8054.00
PST095	1½"	9.5	570	335	•		1.39	1.86	9714.00
PST120	2"	12	720	424		•	1.41	1.89	12316.00
PST140	2"	14	840	494		•	1.38	1.85	13537.00
PST180	2"	18	1080	636		•	1.78	2.39	18061.00
PST220	2½"	22	1320	777		•	1.60	2.15	20725.00
PST260	2½"	26	1560	918		•	2.30	3.08	22807.00
PST300	2½"	30	1810	1065		•	2.90	3.89	24951.00
PST350	2½"	35	2100	1236		•	3.59	4.81	27384.00
PST460	DN100	46	2760	1624		•	3.54	4.75	32699.00
PST520	DN100	52	3120	1836		•	4.31	5.78	37253.00
PST630	DN100	63	3780	2225		•	5.24	7.03	41870.00
PST750	DN150	75	4500	2649		•	6.94	9.31	45459.00
PST900	DN150	90	5400	3178		•	11.13	14.93	51975.00
PST1200	DN150	120	7200	4238		•	11.02	14.78	62207.00
PST1500	DN200	150	9000	5297		•	15.32	20.54	81347.00
CRD1800	DN200	180	10800	6357		•	18.67	25.04	97133.00

Performance refers to air cooled models with air suction of FAD 20°C/1 bar A, and the following operating conditions; air suction 25°C/60% RH, 7 barg (102 psig) working pressure, pressure dewpoint as shown above, 25°C (°F) cooling air temperature, 35°C

Weights and dimensions

Model	Dimensions mm			Weight Kg	Recommended Filtration			
	A	B	C		General Purpose	UNIT PRICE \$	High Efficiency	UNIT PRICE \$
PST075	703	945	562	83	A0035GBFX	588.00	AA035GBFX	1548.00
PST095	703	945	562	83	A0035GBFX	588.00	AA035GBFX	1548.00
PST120	706	1064	1046	145	A0040HBFX	878.00	AA040HBFX	1982.00
PST140	706	1064	1046	145	A0045HBFX	1034.00	AA045HBFX	2721.00
PST180	706	1064	1046	155	A0045HBFX	1034.00	AA045HBFX	2721.00
PST220	806	1316	1166	230	A0050IBFX	1265.00	AA050IBFX	3330.00
PST260	806	1316	1166	240	A0050IBFX	1265.00	AA050IBFX	3330.00
PST300	806	1316	1166	245	A0055IBFX	1442.00	AA055IBFX	3796.00
PST350	806	1316	1166	250	A0055IBFX	1442.00	AA055IBFX	3796.00
PST460	1007	1690	1245	470	A02500DFX*	3192.00	AA2500DFX*	P.O.A.
PST520	1007	1690	1245	490	A02500DFX*	3192.00	AA2500DFX*	P.O.A.
PST630	1007	1722	1657	580	A03000DFX*	3786.00	AA3000DFX*	P.O.A.
PST750	1007	1722	1657	670	A0350PDFX	4501.00	AA350PDFX	P.O.A.
PST900	1007	1722	1657	690	A0350PDFX	4501.00	AA350PDFX	P.O.A.
PST1200	1007	2048	1657	830	A0350PDFX	4501.00	AA350PDFX	P.O.A.
PST1500	1007	2208	2257	1100	A0400QDFX	8054.00	AA400QDFX	P.O.A.
PST1800	1007	2208	2257	1190	A0400QDFX	8054.00	AA400QDFX	P.O.A.

Recommended filtration has been selected based upon the nominal flow rates associated with 3°C (37°F) dewpoint. * Cast aluminium filters also available.

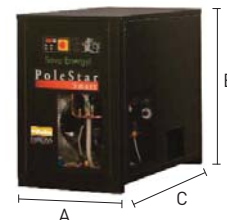

Flow correction factors

Capacity correction factors to be used when operating conditions differ from those shown above. To obtain dryer capacity at new conditions multiply nominal capacity* x C1 x C2 x C3 x C4

Ambient Temperature (C1)

°C	20	25	30	35	40	45	50
Correction Factor	1.06	1.00	0.94	0.88	0.82	0.76	0.70

Inlet Temperature (C2)

°C	30	35	40	45	50	55	60
Correction Factor	1.21	1.00	0.84	0.70	0.59	0.49	0.41

Inlet Pressure (C3)

Pressure bar g	3	4	5	6	7	8	9	10	11	12
Pressure psi g	44	58	73	87	100	116	131	145	160	174
Correction Factor	0.74	0.83	0.90	0.96	1.00	1.03	1.06	1.08	1.10	1.12

Dewpoint (C4)

°C	3	5	7
Correction Factor	1.00	1.1	1.21

To obtain the required air flow, multiply the dryer nominal flow by the above correction factors i.e. Air flow x A x B x C x D. Maximum operating pressure 12 bar g.

PNEUDRI MIDAS

Point of use desiccant dryers (5.1 m³/h to 34 m³/h)



Technical data

Minimum operating pressure:	4 bar g
Maximum operating pressure:	12 bar g (175 psi g)
Maximum inlet temperature:	50°C
Minimum operating temperature:	2°C
Pressure dewpoint:	Nominal -40°C
	Optional -70°C

*Stated flows are for operation at 7 bar g (102 psi g) with reference to 20°C, 1 bar (a), 0% relative water vapour pressure.

Model	Pipe Size Inlet / Outlet BSP	Nominal Inlet Flow Rates* @ 7 bar g (102 psi g)			Dimension A mm	Weight kg	UNIT PRICE \$
		m ³ /min	m ³ /hr	cfm			
DAS1	G ³ / ₈	0.09	5.1	3	422	11	2276.00
DAS2	G ³ / ₈	0.14	8.5	5	500	13	2456.00
DAS3	G ³ / ₈	0.23	13.6	8	616	16	2698.00
DAS4	G ³ / ₈	0.28	17.0	10	692	18	2895.00
DAS5	G ³ / ₈	0.37	22.1	13	847	20	3020.00
DAS6	G ³ / ₈	0.43	25.5	15	906	23	3311.00
DAS7	G ³ / ₈	0.57	34.0	20	1098	28	3845.00

Flow correction factors

Minimum drying capacity = inlet flow requirement x correction factor

Minimum Inlet Pressure		Maximum Inlet Temperature °C			
bar g	psi g	35	40	45	50
4	58	1.59	1.64	1.82	2.17
5	73	1.33	1.37	1.52	1.82
6	87	1.14	1.18	1.30	1.56
7	100	1.00	1.03	1.14	1.37
8	116	1.03	1.06	1.18	1.41
9	135	0.93	0.95	1.05	1.27
10	145	0.85	0.88	0.96	1.16
11	160	0.78	0.80	0.88	1.06
12	175	0.71	0.74	0.81	0.98

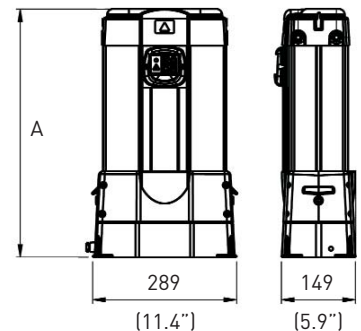

Maintenance kits

Model	Maintenance Kit	UNIT PRICE \$
DAS 1	DASMK1	656.00
DAS 2	DASMK2	687.00
DAS 3	DASMK3	754.00
DAS 4	DASMK4	887.00
DAS 5	DASMK5	936.00
DAS 6	DASMK6	1017.00
DAS 7	DASMK7	1173.00

Accessories

Description	Kit	UNIT PRICE \$
Fixed Wall Mounting Bracket	DASMB1	319.00
45° Tilt Wall Mounting Bracket	DASMB2	531.00
Purge Economy Gland Kit	608203185	64.00
Volt Free Relay Kit	608203186	139.00



NOTES

- It is recommended that an AO pre-filter should be used in addition to the Integral Grade AA filter.
- If odour removal is required, use a Grade ACS filter downstream.
- Electric unit is suitable for 230/1/50.
- DAS models supplied electronic as standard.
- For hazardous areas, fully pneumatic mini and midi dryers are available.
- Remote condensate discharge kit available.
- Remote indication kit available.
- Purge economy as standard on dryers drilling Kit 608203185.

PNEUDRI MIDlplus

Compressed air desiccant dryers

(41 m³/h to 299 m³/h)



Technical data

Minimum operating pressure:	4 bar g (58 psi g)	
Maximum operating pressure:	DME 012-040 MIDlplus Dryers	16 bar g (232 psi g)
	DME 050-080 MIDlplus Dryers	13 bar g (189 psi g)
Minimum inlet temperature:	2°C	
Maximum inlet temperature:	50°C	
Pressure dewpoint:	Nominal	-40°C
	Optional	-70°C

PNEUMATIC OPTION
If you require an approved fully PNEUMATIC dryer, please contact Parker Filtration for details

*Stated flows are for operation at 7 bar g (102 psi g) with reference to 20°C, 1 bar (a), 0% relative water vapour pressure.

Model	Pipe Size Inlet / Outlet BSP	Maximum Inlet Temp	Nominal Inlet Flow Rates* @ 7 bar g (102 psi g)			Dimension A mm	Weight kg	DME UNIT PRICE \$	WITH DDS UNIT PRICE \$
			m ³ /min	m ³ /hr	cfm				
DME012	G ³ / ₄	Upto 35°C	0.68	41	24	837	32	3930.00	6330.00
DME015	G ³ / ₄	Upto 35°C	0.91	54	32	1003	37	4040.00	6501.00
DME020	G ³ / ₄	Upto 35°C	1.19	71	42	1168	42	4572.00	7030.00
DME025	G ³ / ₄	Upto 35°C	1.5	90	53	1333	47	4942.00	7399.00
DME030	G ³ / ₄	Upto 35°C	1.84	110.5	65	1499	52	5978.00	8439.00
DME040	G ³ / ₄	Upto 35°C	2.49	149.5	88	1747	60	7106.00	9564.00
DME050	G1	Upto 35°C	3.0	180	106	1433	80	8420.00	10994.00
DME060	G1	Upto 35°C	3.68	221	130	1599	90	10230.00	12798.00
DME080	G1	Upto 35°C	4.98	299	176	1847	104	10846.00	13414.00

FAULT RELAY KIT 60820 3200 \$105.00

Recommended filtration

For Dryer Model	Filter Pipe Size	General Purpose Pre-filter	UNIT PRICE \$	High Efficiency Inlet Filter	UNIT PRICE \$	Outlet Dust Filter	UNIT PRICE \$
DME012	3/4"	A0020DBFX	536.00	AA020DBFX	536.00	AR020DBMX	536.00
DME015	3/4"	A0020DBFX	536.00	AA020DBFX	536.00	AR020DBMX	536.00
DME020	3/4"	A0020DBFX	536.00	AA020DBFX	536.00	AR020DBMX	536.00
DME025	3/4"	A0020DBFX	536.00	AA020DBFX	536.00	AR020DBMX	536.00
DME030	3/4"	A0020DBFX	536.00	AA020DBFX	536.00	AR020DBMX	536.00
DME040	3/4"	A0025DBFX	911.00	AA025DBFX	911.00	AR025DBMX	911.00
DME050	1"	A0025EBFX	911.00	AA025EBFX	911.00	AR025EBMX	911.00
DME060	1"	A0030EBFX	1020.00	AA030EBFX	1020.00	AR030EBMX	1020.00
DME080	1"	A0030EBFX	1020.00	AA030EBFX	1020.00	AR030EBMX	1020.00

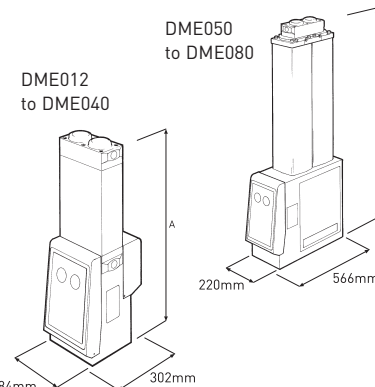

Flow correction factors

Temperature correction factor CFT

Max. Inlet Temp	°C	25	30	35	40	45	50
CFT		1.00	1.00	1.00	1.03	1.14	1.37

Pressure correction factor CFP

Min Inlet Pressure	bar g	4	5	6	7	8	9	10	11	12	13	14	15	16	
	psi g	58	73	87	102	116	131	145	160	174	189	203	218	232	
	CFP	1.60	1.34	1.15	1.00	0.89	0.80	0.73	0.67	0.62	0.58	0.54	0.5	0.47	

Dewpoint correction factor CFD

Required Dewpoint °C	PDP	-20	-40	-70
	CFD	0.91	1.00	1.43

To correctly select a dryer model, the flow rate, maximum temperature and minimum pressure at the dryer inlet, along with the required outlet dewpoint must be known.

- Select correction factor for maximum inlet temperature from the CFT table
- Select correction factor for minimum inlet pressure from the CFP table
- Select correction factor for required outlet dewpoint from the CFD table
- Calculate minimum drying capacity required using the calculation below

$$\text{Minimum Drying Capacity} = \text{Inlet Flow} \times \text{CFT} \times \text{CFP} \times \text{CFD}$$

- Using the minimum drying capacity, select a dryer model from the flow rate tables above (dryer selected must have a flow rate equal to or greater than the minimum drying capacity)

If the minimum drying capacity exceeds the maximum values of the models shown within the tables, please contact Parker Filtration for advice regarding larger multi banked dryers.

NOTES

- It is recommended that an AO pre-filter should be used in addition to a Grade AA filter.
- Prices exclude inlet and outlet filters.
- Grade AAR, high-efficiency dust filters are now available (0.01 micron).
- If Parker Filtration OIL-X EVOLUTION filters are not used for protection of the dryer, warranty may be invalid.
- Electric unit is suitable for 230/1/50.
- DME models supplied electronic as standard.
- For hazardous areas, fully pneumatic mini and midi dryers are available.
- DME012-040 - Wall mounting brackets available. Part No. 60 820 1637.
- DME012-040 - Remote discharge piping available.

PNEUDRI MX Heatless

Compressed air desiccant dryers (from 408 m³/h)



Technical data

Maximum operating pressure	13 barg (190 psi g)
Minimum operating pressure	4 barg (58 psi g)
Maximum inlet temperature	50°C
Minimum inlet temperature	2°C
Noise level	<75 dB(A)
MX (voltage)	85 - 265V ac 50/60Hz

ATEX OPTION
If you require ATEX approved, fully pneumatic dryers, please contact Parker Filtration for further details.

PNEUMATIC OPTION
If you require an approved fully PNEUMATIC dryer, please contact Parker Filtration for details

*Stated flows are for operation at 7 bar g (102 psi g) with reference to 20°C, 1 bar (a), 0% relative water vapour pressure.

Model	Pipe Size	Flowrate @ 7 barg (102 psig)*			Dimensions mm				Weight kg	UNIT PRICE \$
		m ³ /min	m ³ /hr	cfm	A	B	C	D		
MX102c	2"	6.8	408	240	696	326	550	1647	235	PRICE AND DELIVERY ON APPLICATION
MX103c	2"	10.25	612	360	865	495	550	1647	316	
MX103	2"	12.75	765	450	865	495	550	1892	355	
MX104	2"	17.0	1020	600	1034	664	550	1892	450	
MX105	2½"	21.25	1275	750	1203	833	550	1892	543	
MX106	2½"	25.5	1530	900	1372	1002	550	1892	637	
MX107	2½"	29.75	1785	1050	1541	1171	550	1892	731	
MX108	2½"	34.00	2040	1200	1710	1340	550	1892	825	

Recommended filtration

For Dryer Model	Filter Pipe Size	General Purpose Pre-filter	High Efficiency Inlet Filter	Outlet Dust Filter
MX102C	2"	A0040HBFX	AA040HBFX	AR040HBMX
MX103C	2"	A0040HBFX	AA040HBFX	AR040HBMX
MX103	2"	A0045HBFX	AA045HBFX	AR045HBMX
MX104	2"	A0045HBFX	AA045HBFX	AR045HBMX
MX105	2½"	A0050IBFX	AA050IBFX	AR050IBMX
MX106	2½"	A0055IBFX	AA055IBFX	AR055IBMX
MX107	2½"	A0055IBFX	AA055IBFX	AR055IBMX
MX108	2½"	A0055IBFX	AA055IBFX	AR055IBMX

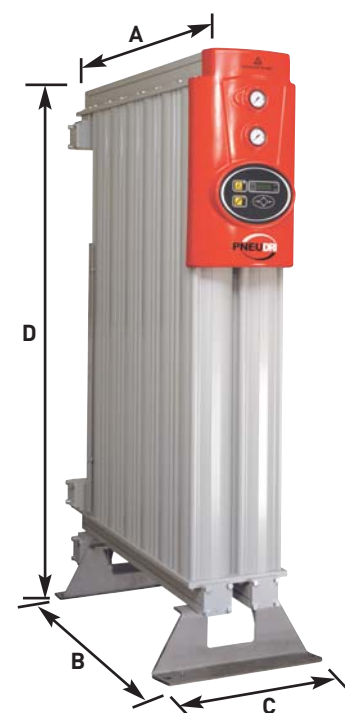

PNEUDRI MX Heatless

Compressed air desiccant dryers



Product selection

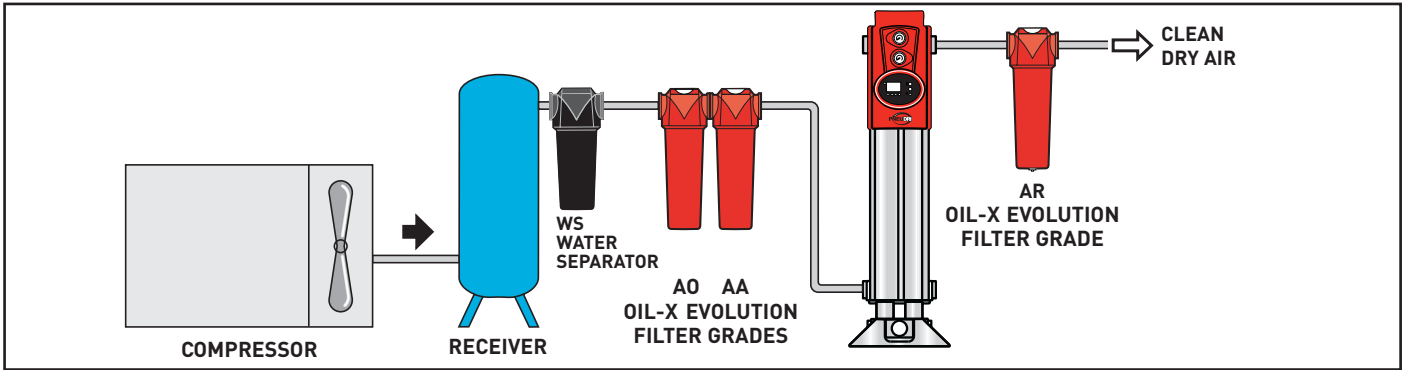

Correction factors

Temperature correction factor CFT

Max. Inlet Temp	°C	25	30	35	40	45	50
	°F	77	86	95	104	113	122
	CFT	1.00	1.00	1.00	1.03	1.14	1.37

Pressure correction factor CFP

Min Inlet Pressure	bar g	4	5	6	7	8	9	10	11	12	13
	psi g	58	73	87	102	116	131	145	160	174	189
	CFP	1.59	1.33	1.14	1.00	0.88	0.80	0.72	0.67	0.61	0.57

Dewpoint correction factor CFD

Required Dewpoint °C (°F)	PDP	-20 (-4)	-40 (-40)	-70 (-100)
	CFD	0.91	1.00	1.43

To correctly select a dryer model, the flow rate, maximum temperature and minimum pressure at the dryer inlet, along with the required outlet dewpoint must be known.

1. Select correction factor for maximum inlet temperature from the CFT table
2. Select correction factor for minimum inlet pressure from the CFP table
3. Select correction factor for required outlet dewpoint from the CFD table
4. Calculate minimum drying capacity required using the calculation below

$$\text{Minimum Drying Capacity} = \text{Inlet Flow} \times \text{CFT} \times \text{CFP} \times \text{CFD}$$

5. Using the minimum drying capacity, select a dryer model from the flow rate tables above (dryer selected must have a flow rate equal to or greater than the minimum drying capacity)

If the minimum drying capacity exceeds the maximum values of the models shown within the tables, please contact Parker Filtration for advice regarding larger multi banked dryers.

Electronic controllers

Dryer control systems

PNEUDRI offers two electronic control options for dryer control.

PNEUDRI SMART

The SMART controller provides system status display, service indication and is now available with the optional Dewpoint Dependant Switching (DDS) Energy Management System, incorporating dewpoint display.

PNEUDRI ADVANCED

The advanced controller provides a full system status display, including dewpoint, temperature and pressure. The DDS Energy Management System is included as standard, ensuring cost effective operation and optimum system performance. This unique, microprocessor controlled system, can be custom configured to monitor individual plant requirements. System warnings and fault alarms can be configured to react in the way that best suits your factory processes. Not only can alarms be indicated remotely, the system can be configured to by-pass or even shut down your air supply in the event that air quality falls outside of the required specification.



PNEUDRI Maxi heat regenerative Compressed air desiccant dryers (from 238 m³/h)



Technical data

Maximum operating pressure	10.5 barg (154 psi g)
Minimum operating pressure	4 barg (58 psi g)
Maximum inlet temperature	50°C
Minimum inlet temperature	2°C
Noise level	<75 dB(A)
Voltage	415V/3ph + Neutral / 50-60Hz

Model	Full load Amps	Power Consumption kW H Average
DH102	7.2	1.1
DH104	14.4	2.2
DH106	21.6	3.3
DH108	28.8	4.4
DH110	36.0	5.5

ELECTRICAL SPECIFICATIONS
(Maxi Heat Regenerative models)
Based on 3 phase, 415Vac and neutral, constant supply.

IMPORTANT:
Please consider voltage drop when sizing electrical supply cables.
Voltage at the dryer must be between +5% to -10%.

*Stated flows are for operation at 7 bar g (102 psi g) with reference to 20°C, 1 bar (a), 0% relative water vapour pressure.

Model	Pipe Size	Nominal Flow Rates* @ 7 bar g (102 psi g)			Dimensions in mm				Weight Kg	UNIT PRICE \$
		m ³ /min	m ³ /hr	cfm	A	B	C	D		
DH102	2"	3.96	238	140	717	264	321	1578	150	PRICE AND DELIVERY ON APPLICATION
DH104	2"	7.92	476	280	947	494	321	1578	245	
DH106	2½"	11.89	714	420	1177	724	321	1578	325	
DH108	2½"	15.85	951	560	1407	954	321	1578	440	
DH110	2½"	19.81	1189	700	1637	1184	321	1578	565	

Recommended filtration

For Dryer Model	Filter Pipe Size	General Purpose Pre-filter	High Efficiency Inlet Filter	Outlet Dust Filter
DH102	2"	A0040HBFX	AA040HBFX	AR040HBMX
DH104	2"	A0040HBFX	AA040HBFX	AR040HBMX
DH106	2½"	A0050IBFX	AA050IBFX	AR050IBMX
DH108	2½"	A0050IBFX	AA050IBFX	AR050IBMX
DH110	2½"	A0050IBFX	AA050IBFX	AR050IBMX

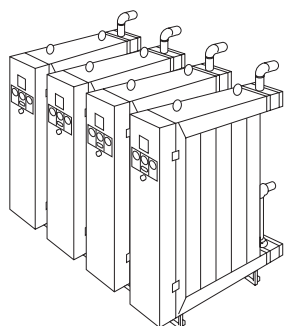
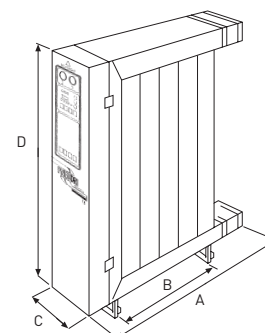

MAXI MULTIPLE BANKS

PNEUDRI's unique modular construction allows for higher flow rates to be catered for simply by using additional banks joined side by side.

Dryer sizing shown at 35°C inlet temperature having a 7 bar g (102 psi g) inlet pressure.

See correction factors on page 38 for other temperatures and pressures.

PNEUDRI H/REGEN OPTIONS	PRODUCT
PNEUDRI electronic with Dewpoint Switching	DHE(Model)/DS
PNEUDRI electronic without Dewpoint Switching	DHE(Model)
PNEUDRI SMART with Dewpoint Switching	DHS(Model)/DS

FOR SYSTEM FLOW RATES IN EXCESS OF THOSE SHOWN IN TABLES, PLEASE CONTACT UK INDUSTRIAL SALES

FOR CRITICAL APPLICATIONS PNEUDRI CAN BE SPECIFIED WITH STAINLESS STEEL HIGH FLOW TETPOR OUTLET FILTER(S)

PNEUDRI Maxi heat regenerative Compressed air desiccant dryers



Product selection

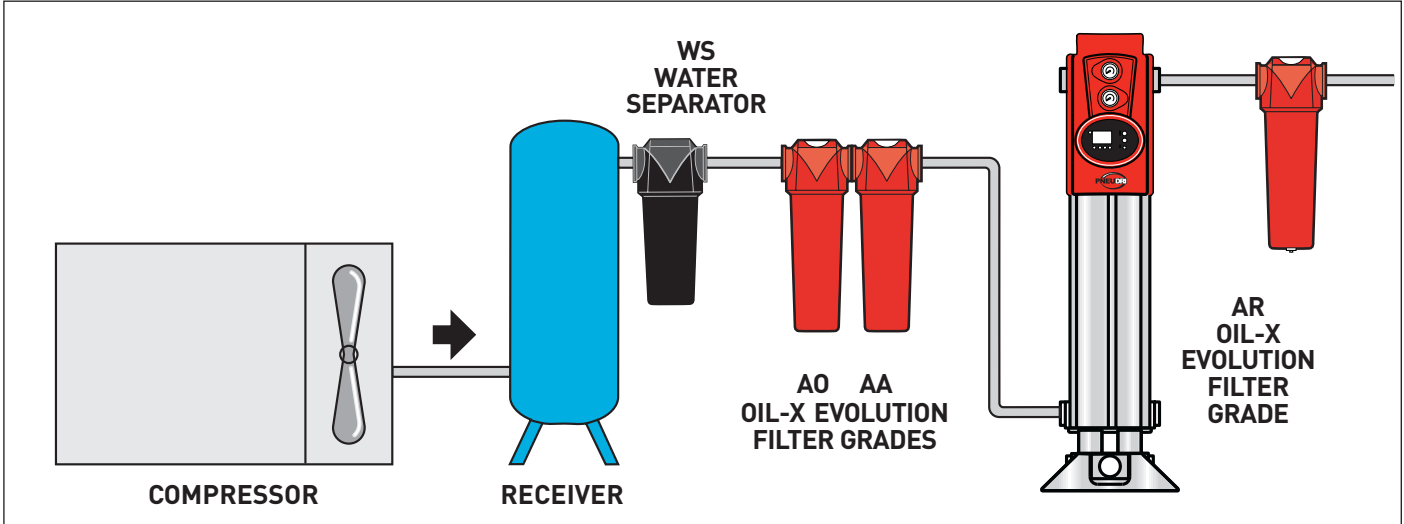

Correction factors

Temperature correction factor CFT

Max. Inlet Temp	°C	25	30	35	40	45	50
	CFT	0.91	1.00	1.00	1.32	1.73	2.23

Pressure correction factor CFP

Min Inlet Pressure	bar g	4	5	6	7	8	9	10	11	12	13
	psi g	58	73	87	102	116	131	145	160	174	189
	CFP	1.60	1.34	1.15	1.00	0.89	0.80	0.73	0.67	0.62	0.58

Dewpoint correction factor CFD

Required Dewpoint °C	PDP	-40	-70
	CFD	1.00	1.43

To correctly select a dryer model, the flow rate, maximum temperature and minimum pressure at the dryer inlet, along with the required outlet dewpoint must be known.

1. Select correction factor for maximum inlet temperature from the CFT table
2. Select correction factor for minimum inlet pressure from the CFP table
3. Select correction factor for required outlet dewpoint from the CFD table
4. Calculate minimum drying capacity required using the calculation below

$$\text{Minimum Drying Capacity} = \text{Inlet Flow} \times \text{CFT} \times \text{CFP} \times \text{CFD}$$

5. Using the minimum drying capacity, select a dryer model from the flow rate tables above (dryer selected must have a flow rate equal to or greater than the minimum drying capacity)

If the minimum drying capacity exceeds the maximum values of the models shown within the tables, please contact Parker Filtration for advice regarding larger multi banked dryers.

Energy Savings - PNEUDRI MX Heatless and PNEUDRI DH Heat Regenerative

The energy consumed by PNEUDRI is based upon the assumption that the desiccant bed requiring regeneration has been fully utilised. In practice, a dryer is rarely operating to 100% of its capacity 100% of the time and at the end of the drying / regenerating cycle when the air flow is about to switch from the drying chamber to the regenerated chamber, there is probably drying capacity remaining in the desiccant bed about to undergo regeneration. As the energy used to regenerate the off-line column is based upon the assumption the bed is fully saturated, more energy is consumed than is actually necessary.

Dewpoint Dependant Switching (DDS) Energy Management System

At the point of column changeover, both sides of the dryer are at full line pressure, the exhaust valves are closed, no purge air is consumed and the energy consumption is zero. A PNEUDRI dryer fitted with the DDS energy management system will monitor the quality of the air leaving the dryer and will stop the changeover if the dewpoint of the air is drier than required. The partially saturated bed continues to dry the incoming compressed air and the DDS system continues to monitor the air leaving the dryer. Only when the air has become wetter than the user set dewpoint will the dryer change over. The cycle will then continue until the next column changeover when the DDS may again extend the drying period as dictated by the outlet air quality. The DDS system will ensure the energy consumed is directly proportional to the amount of water vapour present and not the dryers rated capacity.

DTX heatless

Compressed air desiccant dryers



Technical data

Flow Range @ 7 bar g:	145m³/h to 6100m³/h	
Dewpoint:	-20°C Optional, -40°C Standard -70°C Optional	
Maximum operating pressure:	DTX 3-36	16 bar g (232 psi g)
	DTX 42-84	10 bar g (145 psi g) 4 bar g (58 psi g)
Minimum operating pressure:	4 bar g (58 psi g)	
Maximum inlet temperature:	50°C	
Minimum inlet temperature:	5°C	
Controls:	Electronic or Pneumatic	
Dewpoint control optional		
Standard electrical supply:	230V/1Ph/50Hz - 60Hz	

Model	Air Connections	Flowrate* @ 7 barg (102 psi g)			Dimensions in mm			Weight Kg	UNIT PRICE \$
		m³/min	m³/hr	cfm	A	B	C		
DTX 15	G1	2.42	145	85	670	1690	515	143	PRICE AND DELIVERY ON APPLICATION
DTX 20	G1	3.33	200	118	670	1710	530	178	
DTX 25	G1	4.25	255	150	710	1770	535	218	
DTX 35	G1½	5.83	350	206	841	1790	570	252	
DTX 45	G1½	7.00	420	247	841	1815	570	286	
DTX 60	G1½	10.33	620	365	841	1845	590	375	
DTX 75	G2	12.50	750	441	1010	1980	610	430	
DTX 95	G2	15.67	940	553	1010	2000	630	505	
DTX 120	DN50	20.00	1200	706	1060	2080	840	640	
DTX 150	DN65	25.83	1550	912	1270	2120	900	830	
DTX 200	DN65	33.33	2000	1177	1350	2160	990	955	
DTX 250	DN80	41.67	2500	1471	1530	2210	1040	1075	
DTX 300	DN80	50.00	3000	1766	1600	2255	1100	1500	
DTX 380	DN100	60.00	3800	2119	1875	2385	1200	1990	
DTX 500	DN100	80.83	4850	2855	1925	2660	1250	2410	
DTX 600	DN125	101.67	6100	3590	2160	2820	1565	2850	

*Referenced to 20°C and 1 bar a (14.5 psi a)

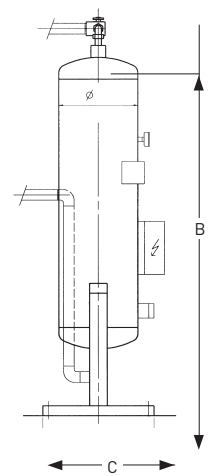

Correct dryer selection

- Select your correction factor for minimum pressure (CFP) to inlet of dryer (Allow for system pressure losses when determining minimum operating pressure).

Minimum Pressure to inlet of Dryer	bar g	4	5	6	7	8	9	10	11	12	13	14	15	16
	psi g	58	73	87	102	116	131	145	160	174	189	203	218	232
Correction Factor [CFP]		0.63	0.75	0.88	1.0	1.13	1.25	1.38	1.5	1.6	1.8	1.9	2.0	2.13

- Select your correction factor for maximum temperature (CFT) to inlet of dryer.

Maximum Temp. to inlet of Dryer	°C	25	35	40	45
Heatless DTX Dryers (CFT)		1.0	1.0	0.8	0.62

- Calculate dryer capacity required following the equation below.

$$\text{Inlet flow requirement} = \frac{\text{Dryer capacity requirements}}{\text{CFP} \times \text{CFT}}$$

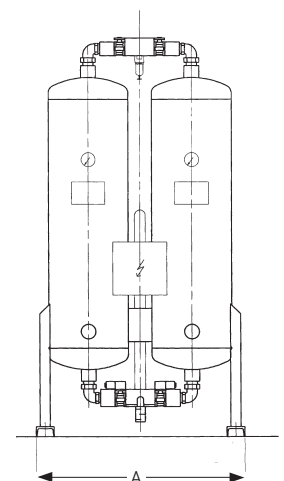

DTV Zero purge

Vacuum heat regenerated dryers



Technical data

Flow range @ 7 bar g (102 psi g):	420m ³ /hr to 14500m ³ /hr
Dewpoint:	-40°C Nominal, -20°C Optional, -70°C Optional
Maximum operating pressure:	10 bar g (145 psi g) 16 bar g (232 psi g) optional
Minimum operating pressure:	4 bar g (58 psi g)
Maximum inlet temperature:	40°C
Minimum inlet temperature:	5°C
Controls:	Microprocessor or PLC
Dewpoint control optional	
Standard electrical supply:	400V/3Ph/50Hz ± 5%

PATENTED
vacuum
TECHNOLOGY

Model	Air Connections	Flowrate* @ 7 barg inlet temp. 35°C			Dimensions in mm			Kg	Average Power kW/h @ Dewpoint	
		m ³ /min	m ³ /hr	cfm	A	B	C		-25°C	-40°C
DTV 19	DN 40	7.0	420	247	1215	1955	992	460	3.1	3.4
DTV 22	DN 40	8.5	510	300	1215	2205	992	560	3.8	4.1
DTV 28	DN 50	10.7	640	377	1305	2250	1085	750	5.2	5.5
DTV 34	DN 50	14.2	850	500	1360	2275	1120	800	6.7	7.2
DTV 43	DN 80	19.7	1180	695	1560	2665	1265	1154	10.9	11.8
DTV 47	DN 80	25.0	1500	883	1610	2680	1265	1350	12.8	13.0
DTV 55	DN 80	33.0	1980	1165	1700	2730	1585	1720	16.3	17.5
DTV 59	DN 100	39.2	2350	1383	2020	2845	1450	1880	18.1	19.5
DTV 65	DN 100	48.8	2930	1725	2080	2870	1580	2350	22.5	24.2
DTV 70	DN 100	59.2	3550	2089	2170	2940	1740	2850	27.9	29.3
DTV 73	DN 150	68.3	4100	2413	2450	3190	1780	4000	32.5	34.2
DTV 79	DN 150	79.0	4740	2790	2550	3210	2110	4100	38.9	40.2
DTV 82	DN 150	87.5	5250	3090	2550	3230	1995	4200	44.8	45.2
DTV 88	DN 150	103.5	6210	3655	2600	3500	1910	4950	52.3	53.2
DTV 91	DN 150	118.3	7100	4179	2650	3520	1940	5700	56.3	57.0
DTV 94	DN 200	133.3	8000	4709	3100	3585	2180	6400	67.2	67.8
DTV 97	DN 200	153.3	9200	5415	3150	3605	2300	7400	75.6	76.8
DTV 100	DN 200	180.0	10800	6357	3250	3670	2355	8700	85.3	87.9
DTV 103	DN 250	205.0	12300	7240	3500	3855	2515	11500	98.9	105.0
DTV 106	DN 250	241.7	14500	8534	3600	3895	2570	13500	111.4	119.9

UNIT PRICE \$

PRICE AND DELIVERY ON APPLICATION

*Referenced to 20°C and 1 bar a (14.5 psi a)

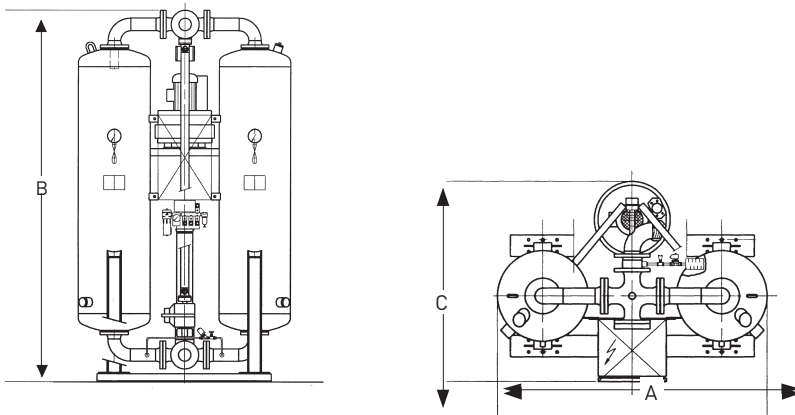

OIL-X EVOLUTION BA Units

High efficiency breathing air purifiers



1 Million times cleaner than the normal air we breathe

Particle removal down to 0.01 micron, including water and oil aerosols. Maximum remaining oil vapour content: 0.003mg/m3 at 21°C

domnick hunter breathing air purifiers are suitable for critical applications where only the finest quality compressed air is acceptable. For example: dental air, paint spraying, breathing air etc, where carbon monoxide (CO) and carbon dioxide (CO2) contamination does not constitute a hazard. Supply can be taken from most sources of compressed air, either directly from the compressor or from the ring main. These breathing air purifiers utilise two separate stages of air treatment combined together in one compact housing. Where the air supply is particularly dirty, these purifiers can be supplied with additional AO grade filtration, and WS water separators.

Model	No. of people	Water separator	Prefilter	2 stage filter	Regulator	Gauge	Port size	No. of couplings	Mounting bracket	Portable frame	Unit Price \$
BAE21B0	1-2			X	X	X	1/4	1	X		682.00
BAE22B0	1-2		X	X	X	X	1/4	1	X		981.00
BAE23B0	1-2	X	X	X	X	X	1/4	1	X		1195.00
BAE21BP	1-2			X	X	X	1/4	1		X	813.00
BAE22BP	1-2		X	X	X	X	1/4	1		X	1096.00
BAE23BP	1-2	X	X	X	X	X	1/4	1		X	1316.00
BAE41B0	2-4			X	X	X	3/8	2	X		1086.00
BAE42B0	2-4		X	X	X	X	3/8	2	X		1129.00
BAE43B0	2-4	X	X	X	X	X	3/8	2	X		1568.00
BAE41BP	2-4			X	X	X	3/8	2		X	1231.00
BAE42BP	2-4		X	X	X	X	3/8	2		X	1257.00
BAE43BP	2-4	X	X	X	X	X	3/8	2		X	1801.00

BAE 2*** includes 1 outlet coupling, BAE 4*** includes 2 outlet couplings. Extra couplings available on request: Part no. 3441262 \$82.00

BAE21B0 to BAE43BP

Low pressure system (up to 16 barg with auto drain)

Maximum Operating Pressure	16 bar g (20 bar g with manual drain)	232 psi g
Minimum Operating Pressure	1 bar g	15 psi g
Maximum Recommended Operating Temperature	30°C	86°F
Minimum Recommended Operating Temperature	1.5°C	35°F

WARNING!

These units will not remove carbon monoxide (CO), carbon dioxide (CO2) or other toxic gases or fumes. CO and CO2 removal systems are available upon request. Consult your respiratory safety specialist for further advice on domnick hunter purifiers for these requirements.

Replacement Elements

Model	Pre Filter	Unit Price \$	Coalescing filter	Unit Price \$	Activated Carbon	Unit Price \$
BAE21B0	-	-	010AA	115.00	010AC	66.00
BAE22B0	010AO	115.00	010AA	115.00	010AC	66.00
BAE23B0	010AO	115.00	010AA	115.00	010AC	66.00
BAE21BP	-	-	010AA	115.00	010AC	66.00
BAE22BP	010AO	115.00	010AA	115.00	010AC	66.00
BAE23BP	010AO	115.00	010AA	115.00	010AC	66.00
BAE41B0	-	-	015AA	184.00	015AC	84.00
BAE42B0	015AO	184.00	015AA	184.00	015AC	84.00
BAE43B0	015AO	184.00	015AA	184.00	015AC	84.00
BAE41BP	-	-	015AA	184.00	015AC	84.00
BAE42BP	015AO	184.00	015AA	184.00	015AC	84.00
BAE43BP	015AO	184.00	015AA	184.00	015AC	84.00

Note- The Water Separator does not have an element that needs replacing

Change (AA/AO Grade) elements every 12 months minimum or when odour or vapour is detected (AC Grade)

Breathing Air Hoses with Safety Couplings

BA TUBE	5 Metre	10 Metre	15 Metre	20 Metre	30 Metre	40 Metre
Unit Price \$	147.00	169.00	191.00	213.00	257.00	300.00

Designed to meet the air purity requirements of AS/NZS1715:1994. Minimum breathing air supply requirement is 170L/min per person at the mask. Maximum design flow rate at 700 kPa inlet pressure is: 360 L/min for 1-2 persons, 780 L/min for 3-4 persons. WARNING: These units will not remove carbon monoxide (CO), carbon dioxide (CO2) or other toxic gases or fumes. CO and CO2 removal systems are available upon request. Consult your respiratory safety specialist for further advice on domnick hunter purifiers for these requirements.



To maintain your guaranteed air quality, filter elements must be replaced every year with genuine domnick hunter parts.

Respiratory protection



BA-PAC purifiers

(Belt mounted AC pack with Flow Regulator)



Technical data

Maximum operating pressure:	10.5 bar g (154 psi g)
Minimum operating pressure:	3 bar g (44 psi g)

Maximum working temperature:	30°C
Minimum working temperature:	1.5°C
Operating pressure differential:	100 m bar g (4 psi)
*Recommended pressure differential for element change:	400 m bar (6 psi d)

Model	Nominal Flow Rates										UNIT PRICE \$	Replacement Elements		
	bar g		3	4	5	6	7	8	9	10.5		Code	Quantity	UNIT PRICE \$
BA-PAC	Maximum Flow Capacity	L/m	300	345	387	423	459	489	519	561	381.00	EAPC1/6	1	381.00
		cfm	10	11.5	12.9	14.1	15.3	16.3	17.3	18.7				
	Maximum Regulated Flow Rate	L/m	160	184	206	226	245	261	277	299				
		cfm	5.5	6.3	7.1	7.7	8.4	9.0	9.5	10.3				



BA - 1400 & BA - 4350

Technical data

Maximum operating pressure:	10 bar g (145 psi g)
Minimum operating pressure:	4 bar g (58 psi g)
Maximum operating temperature:	30°C
Minimum operating temperature:	1.5°C
Weight:	8 Kg



Model	Pipe Size		Nominal Flow Rates								UNIT PRICE \$	Replacement Elements		
	Inlet	Outlet	bar g	4	5	6	7	8	9	10		Code	Quantity	UNIT PRICE \$
BA-4350	G ³ / ₄	4 x G ¹ / ₄	L/m	1064	1190	1302	1400	1498	1582	1666	1924.00	K017ACS	1	179.00
BA-1400			cfm	36.5	41	45	48	51	54	57	2650.00	K017AO	1	179.00
BA-1400B			m ³ /hr	63	70.5	77	83	88	93	98	9385.00	K017AA	1	179.00

NOTES

- Optional baseplate model - part no. 60 500 7760.
- BA1400 Model available with optional CO monitor/alarm (BA-1400B)

IMPORTANT

These units will NOT remove methane, carbon dioxide, carbon monoxide or other toxic gases or fumes. Suitable for use with both mineral and synthetic lubricated compressors.

Respiratory protection



domnick hunter Breathing Air filters have been designed to provide a cost effective solution to compressed air contamination, with delivered air quality to the latest ISO 8573.1 : 2001 international standards, and with the lowest of operational costs. Designed to be installed directly at the point of use, Breathing Air filters combine two grades of filtration into one convenient housing. Liquid aerosols and solid particles are removed using a deep pleated high efficiency coalescing filter element, whilst oil vapours are removed by an activated carbon adsorption cartridge. Each Breathing Air filter employs a unique, air flow management system to ensure pressure losses start low and stay low throughout the life of the filter elements. This ensures operational costs are kept as low as possible.

Former BA Unit (Oil-X Plus) Replacement Elements

For units purchased before February 2007

Model	Pre Filter	Unit Price \$	Coalescing filter	Unit Price \$	Activated Carbon	Unit Price \$
BA21B0	-	-	K009AA	113.00	K006AC	63.00
BA22B0	K009AO	113.00	K009AA	113.00	K006AC	63.00
BA23B0	K009AO	113.00	K009AA	113.00	K006AC	63.00
BA21BP	-	-	K009AA	113.00	K006AC	63.00
BA22BP	K009AO	113.00	K009AA	113.00	K006AC	63.00
BA23BP	K009AO	113.00	K009AA	113.00	K006AC	63.00
BA41B0	-	-	K017AA	179.00	K013AC	81.00
BA42B0	K017AO	179.00	K017AA	179.00	K013AC	81.00
BA43B0	K017AO	179.00	K017AA	179.00	K013AC	81.00
BA41BP	-	-	K017AA	179.00	K013AC	81.00
BA42BP	K017AO	179.00	K017AA	179.00	K013AC	81.00
BA43BP	K017AO	179.00	K017AA	179.00	K013AC	81.00

Note- The Water Separator does not have an element that needs replacing

Change elements every 12 months minimum (AO/AA Grade) and when odour or vapour is detected (AC Grade)

WARNING!
 These units will not remove carbon monoxide (CO), carbon dioxide (CO2) or other toxic gases or fumes. CO and CO2 removal systems are available upon request. Consult your respiratory safety specialist for further advice on domnick hunter purifiers for these requirements.

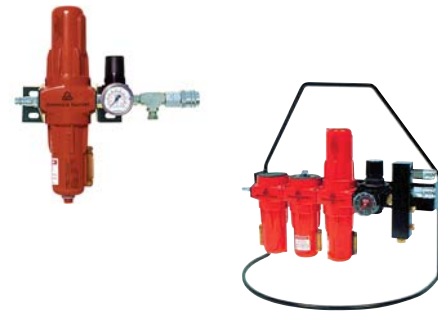

Deigned to meet the air purity requirements of AS/NZS1715:1994. Minimum breathing air supply requirement is 170L/min per person at the mask. Maximum design flow rate at 700 kPa inlet pressure is: 360 L/min for 1-2 persons, 780 L/min for 3-4 persons.



Respiratory protection

Incorporating CO & CO₂ reduction



BA-2010 & BAP-2010

Technical data

Maximum operating pressure:	10 bar g (145 psi g)
Minimum operating pressure:	4 bar g (58 psi g)
Maximum recommended operating temperature:	30°C
Minimum recommended operating temperature:	5°C



Model	Pipe Size		Outlet Flow Rates*								UNIT PRICE \$	Replacement Elements		
	Inlet	Outlet	bar g	4	5	6	7	8	9	10		Code	Quantity	UNIT PRICE \$
BA-2010	G ^{1/2}	3x G ^{1/4}	L/s	5.7	6.75	7.9	9	10.2	11.25	12.4	9673.00	K017AA	1	179.00
			cfm	11.3	13.5	15.8	18	20.3	22.5	24.8		K013AC	1	81.00
BAP-2010			m ³ /hr	20.2	24.0	28.2	32	36.2	40.0	44.2	13218.00	K013HC	1	522.00
												K017AA	1	179.00

* Referenced to 20°C and 1 bar a (14.5 psi a).

NOTES

1. BA-2010 model is totally pneumatic in operation.
2. Hours run meter fitted as standard.

Medical / Breathing air purifiers

BA-DME

Technical data

Maximum operating pressure:	BA - DME 012-040	16 bar g (232 psi g)
	BA - DME 050-080	13 bar g (189 psi g)
Minimum operating pressure:		4 bar g (58 psi g)
Maximum recommended operating temperature:		30°C
Minimum recommended operating temperature:		5°C
Standard electrical supply options:		110V, 230Vac/1ph/50-60Hz



Model	Pipe size		Outlet Flow Rate @ 7 bar g (100 psi g)*			UNIT PRICE \$
	Inlet	Outlet	cfm	L/s	m ³ /hr	
BA-DME012	1/2"	3/8"	19	9	32	P.O.A.
BA-DME015	1/2"	3/4"	25	12	43	P.O.A.
BA-DME020	1/2"	3/4"	33	15	57	P.O.A.
BA-DME025	1/2"	3/4"	42	20	72	P.O.A.
BA-DME030	1/2"	3/4"	52	24	88	P.O.A.
BA-DME040	3/4"	3/4"	70	33	119	P.O.A.
BA-DME050	1"	1"	84	40	144	P.O.A.
BA-DME060	1"	1"	104	49	176	P.O.A.
BA-DME080	1"	1"	140	66	239	P.O.A.

* Referenced to 20°C (68°F) and 1 bar a (14.5 psi a).

NOTES

1. Available with Dewpoint Switching Option, details on request.

Medical air purifiers



BAM 102 - 110

Technical data

Min / maximum operating pressure:	4 - 10.5 bar g (58 - 152 psi g)
Min / maximum inlet temperature:	5°C - 30°C
Electrical supply:	230 V ac / 1Ph / 50 Hz



Model	Connections		Flow Rates @ 7.0 bar g (102 psi g)*				UNIT PRICE \$	Contaminant	European Pharmacopoeia	Parker Filtration BA DME/E Range*
	Inlet	Outlet	Inlet		Outlet					
			l/s	cfm	l/s	cfm				
BAM102	G1½	G2	76	160	63	134	PRICE AND DELIVERY ON APPLICATION	Water	60 ppm (= 47°C adp)	16 ppm (= -57°C adp)
BAM103	G1½	G2	113	240	95	202		Oil/Lubricant	0.1 mg/m ³	0.003 mg/m ³
BAM104	G2	G2	151	320	127	269		Carbon Dioxide (CO ₂)	< 500 ppm	< 300 ppm
BAM105	G2	G2	189	400	159	337		Carbon Monoxide (CO)	< 5 ppm	< 5 ppm
BAM106	G2	G2½	227	480	190	404		Nitrogen Oxides (NO + NO ₂)	< 2 ppm	< 2 ppm
BAM107	G2	G2½	264	560	222	471		Sulphur Dioxide (SO ₂)	< 1 ppm	< 1 ppm
BAM108	G2	G2½	302	640	254	539				
BAM110	G2½	G2½	378	800	318	674				

* Referenced to 20°C and 1 bar a (14.5 psi a).

i SEE PUBLICATION REF: 4435

Medical vacuum filters

Technical data

Maximum operating pressure:	16 bar g, 232 psi g
Maximum recommended operating temp:	100°C (MV010 - 055), 66°C (MV060K)
Minimum recommended operating temp:	1.5°C

Complete bacterial removal to 0.0001% penetration when tested to BS.3928 efficiency, exceeding the requirements of the DHSS for infectious disease units (HTM2022).



Model*	Pipe Connection options*	Free Air capacity at atmospheric**		UNIT PRICE \$	Replacement Elements		
		L/min	cfm		Code	Quantity	UNIT PRICE \$
MV010 □	¼" ⅜" ½"	60	2	437.00	010MV	1	117.00
MV015 □	⅜" ½"	160	6	537.00	015MV	1	185.00
MV020 □	½" ¾" 1"	250	9	785.00	020MV	1	215.00
MV025 □	¾" 1"	450	16	1043.00	025MV	1	265.00
MV030 □	1" 1¼" 1½"	900	32	1355.00	030MV	1	310.00
MV035 □	1¼" 1½"	1500	53	1511.00	035MV	1	349.00
MV040 □	1½" 2"	2000	71	2256.00	040MV	1	416.00
MV045 H	2"	2500	88	2366.00	045MV	1	596.00
MV050 □	2½" 3"	3500	124	2996.00	050MV	1	702.00
MV055 □	2½" 3"	5000	176	3320.00	055MV	1	943.00
MV060 K	4"	9000	318	5971.00	060MV	3	595.00

* Select which pipe connection you require by cross referencing with table below and insert letter into Model Code. eg. MV010C.

A = ¼" B = ⅜" C = ½" D = ¾" E = 1" F = ¾" G = 1½" H = 2" I = 2½" J = 3" K = 4"

** The above flow rates are based upon an initial resistance of 50mm/Hg Higher capacity filters available on request. Filter supplied with sterilisable drain flask and bio-hazard labels.

(1) To find the capacity of an MV filter at a known vacuum condition, multiply the filter Free Air Capacity in the table opposite by correction factor C1. (2) To select a filter to match system flow conditions, multiply the system flow by the correction factor C2 that corresponds to vacuum in the pipe.

Accessories

Description	Kit	UNIT PRICE \$
MV15 - 100G Drain Flask	VF250S	139.00
MV010 - MV060 EVOLUTION Drain Flask	VF250/EVO	169.00

Vacuum		Correction Factors	
mbar (a)	torr or mmHg	C1	C2
1000	750	1.00	1.0
900	675	0.9	1.1
800	600	0.8	1.3
700	525	0.7	1.4
600	450	0.6	1.7
500	375	0.5	2.0
400	300	0.4	2.5
300	225	0.3	3.3
200	150	0.2	5.0
100	75	0.1	10.0

Breathing air purity test kit APTK1

Air quality testing for compressed air systems



This comprehensive test kit is compact, easy to operate and can be used to indicate the level of contamination both upstream and downstream of purification equipment.

The Parker Filtration Air Purity Test Kit APTK1 comes complete with oil mist, water vapour CO & CO₂ test tubes. All test tubes are supplied in packs of ten to allow immediate multiple testing.

Type	Measurable	Sample rate	Test Duration	Total Volume	UNIT PRICE \$
APTK1 606035050	CO	100ml/min	1.5 minutes	150ml	P.O.A.
	CO ₂	100ml/min	3 minutes	300ml	
	Water Vapour	100ml/min	10 minutes	1000ml	
	Oil Mist (Mineral)	1000ml/min	60 minutes	60,000ml	
	Oxygen	50ml/min	Real-time Display	n/a	

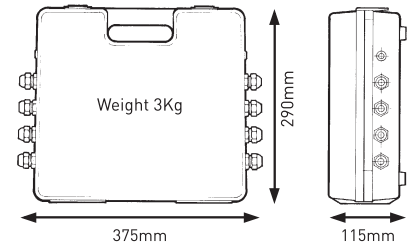

Replacement Gas Detection Tubes / O ₂ Analyser	NETT PRICE \$
Contaminant	
Carbon Monoxide (CO)	P.O.A.
Carbon Dioxide (CO ₂)	P.O.A.
Water Vapour (H ₂ O)	P.O.A.
Oil Mist	P.O.A.
O ₂ Analyser	P.O.A.

NB. All flow rates are factory set to allow immediate testing.

OIL-X EVOLUTION

Vacuum pump inlet filters

Technical data

Operating temperature range:	1.5°C - 100°C
Maximum operating vacuum:	1 Torr



Filtration Efficiency : Particle removal down to 1 micron

Filter Type	Pipe size	Free air capacity at atmospheric*		UNIT PRICE \$	Replacement Element Kit	UNIT PRICE \$
		m³/hr	cfm			
AR010ABMX	¼"	3.6	2	387.00	010AR	115.00
AR010BBMX	⅜"	3.6	2	387.00	010AR	115.00
AR010CBMX	½"	3.6	2	387.00	010AR	115.00
AR015BBMX	⅜"	9.6	6	482.00	015AR	184.00
AR015CBMX	½"	9.6	6	482.00	015AR	184.00
AR020CBMX	½"	15	9	536.00	020AR	213.00
AR020DBMX	¾"	15	9	536.00	020AR	213.00
AR020EBMX	1"	15	9	536.00	020AR	213.00
AR025DBMX	¾"	27	16	911.00	025AR	264.00
AR025EBMX	1"	27	16	911.00	025AR	264.00
AR030EBMX	1"	54	32	1020.00	030AR	308.00
AR030FBMX	1 ¼"	54	32	1020.00	030AR	308.00
AR030GBMX	1 ½"	54	32	1020.00	030AR	308.00
AR035FBMX	1 ¼"	90	53	1548.00	035AR	347.00
AR035GBMX	1 ½"	90	53	1548.00	035AR	347.00
AR040GBMX	1 ½"	120	71	1982.00	040AR	413.00
AR040HBMX	2"	120	71	1982.00	040AR	413.00
AR045HBMX	2"	150	88	2721.00	045AR	592.00
AR050IBMX	2 ½"	210	124	3330.00	050AR	695.00
AR050JBMX	3"	210	124	3330.00	050AR	695.00
AR055IBMX	2 ½"	300	176	3796.00	055AR	937.00
AR055JBMX	3"	300	176	3796.00	055AR	937.00

*Stated flows are for operation at 1 bar a (750 torr) with reference to 20°C, 1 bar a, 0% relative water vapour pressure.

NOTES

- Manual drain valves are supplied as standard.
- Mounting bracket kits available.
- A direct mounting differential pressure indicator (DPVI) is available.
- Larger size fabricated vessels available on request.

OIL-X EVOLUTION

Vacuum pump exhaust filters

Technical data

Operating temperature range:	1.5°C - 100°C
Maximum operating pressure:	20 bar g



Filtration Efficiency : Particle removal down to 1 micron, including water and oil aerosols. Maximum remaining oil content 1mg/m³ (1ppm) at 21°C.

Filter Type	Pipe size	Free air capacity at atmospheric*		UNIT PRICE \$	Replacement Element Kit	UNIT PRICE \$
		m³/hr	cfm			
AR010ABMX	¼"	3.6	2	387.00	010AR	115.00
AR010BBMX	⅜"	3.6	2	387.00	010AR	115.00
AR010CBMX	½"	3.6	2	387.00	010AR	115.00
AR015BBMX	⅜"	9.6	6	482.00	015AR	184.00
AR015CBMX	½"	9.6	6	482.00	015AR	184.00
AR020CBMX	½"	15	9	536.00	020AR	213.00
AR020DBMX	¾"	15	9	536.00	020AR	213.00
AR020EBMX	1"	15	9	536.00	020AR	213.00
AR025DBMX	¾"	27	16	911.00	025AR	264.00
AR025EBMX	1"	27	16	911.00	025AR	264.00
AR030EBMX	1"	54	32	1020.00	030AR	308.00
AR030FBMX	1 ¼"	54	32	1020.00	030AR	308.00
AR030GBMX	1 ½"	54	32	1020.00	030AR	308.00
AR035FBMX	1 ¼"	90	53	1548.00	035AR	347.00
AR035GBMX	1 ½"	90	53	1548.00	035AR	347.00
AR040GBMX	1 ½"	120	71	1982.00	040AR	413.00
AR040HBMX	2"	120	71	1982.00	040AR	413.00
AR045HBMX	2"	150	88	2721.00	045AR	592.00
AR050IBMX	2 ½"	210	124	3330.00	050AR	695.00
AR050JBMX	3"	210	124	3330.00	050AR	695.00
AR055IBMX	2 ½"	300	176	3796.00	055AR	937.00
AR055JBMX	3"	300	176	3796.00	055AR	937.00

*Stated flows are for operation at 7 bar g (102 psi g) with reference to 20°C, bar a, 0% relative water vapour pressure.

NOTES

- Manual drain valves are supplied as standard.
- Mounting bracket kits available.
- Larger size fabricated vessels available on request.

VH-2000 Variable temperature compressed air heaters

Variable Temperature Control up to 100°C



Technical data

Maximum working pressure	16 bar g (232 psi g)
Air inlet temperature	1.5°C - 66°C
Operating voltage	230V 50Hz (+/- 10%)
Maximum continuous current	5.5A
Maximum power consumption	1.3KW

Optional Accessories

Outlet temperature gauge (605009828)
Mounting bracket kit (605009829)

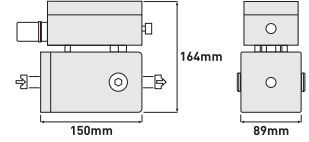

Model	Pipe Size	Flow Rates @ 7 bar g (100 psi g) ANR		
		m³/min	m³/hr	cfm
VH2000	G ³ / ₈ "	0.78	46.8	27
VH2100	G ¹ / ₂ "	0.78	46.8	27

UNIT PRICE \$
3899.00
3899.00

CE Marked for compliance with European regulations EN60204, EN50081-1, EN61000-6-2, EN61000-3-2, EN61000-3-3.

Heater Bracket	605009829	\$185.00
Thermometer Kit	605009828	\$583.00

MIST-X Exhaust silencer mist eliminators

Technical data

Typical operating temperature range:	2-50°C	
Typical back pressure at full rated flow:	MIST-X 25	870 m bar (12.6 psi)
	MIST-X 50	900 m bar (13 psi)
	MIST-X 150	900 m bar (13 psi)



Filter Type	Port Size	Max. Flow Rate @ 7 bar g (100 psi g)			UNIT PRICE \$
		m³/min	m³/hr	cfm	
MIST-X 25	G ¹ / ₂	1.50	90.0	53	122.00
MIST-X 50	G1	2.97	178.4	105	154.00
MIST-X 150	G ¹ / ₂	8.92	535.2	315	207.00

OIL-Xplus - 0003G compressed air filters

Grade	A0	AA	ACS	AR	AAR	AX
Particle Removal Down to:	1 micron	0.01 micron	N/A	1 micron	0.01 micron	0.01 micron
Max. Remaining Oil Content at 21°C (70°F)	0.6 mg/m³ (0.5 ppm)	0.01 mg/m³ (0.01 ppm)	0.003 mg/m³ (0.003 ppm)	N/A	N/A	0.003 mg/m³ (0.003 ppm)
Max. Operating Pressure	10.5 bar g (145 psi g)	10.5 bar g (145 psi g)	10.5 bar g (145 psi g)	10.5 bar g (145 psi g)	10.5 bar g (145 psi g)	10 bar g (145 psi g)
Max. Recommended Operating Temperature	50°C	50°C	30°C	50°C	50°C	50°C
Min. Recommended Operating Temperature	1.5°C	1.5°C	1.5°C	1.5°C	1.5°C	1.5°C
Initial Dry Pressure Differential	70 mbar (1.0 psi)	100 mbar (1.5 psi)	70 mbar (1.0 psi)	70 mbar (1.0 psi)	200 bar (3.0 psi)	200 mbar (3.0 psi)
Initial Saturated Pressure Differential	140 mbar (2.0 psi)	200 mbar (3.0 psi)	-	-	-	400 mbar (6.0 psi)

Dimensions

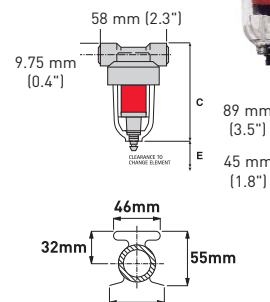

Weight: 0.1 Kg (0.2 lb)

Model	Flow rate at maximum pressure			UNIT PRICE \$	
	Connections	m³/min	m³/hr		cfm
A0-0003G	8mm / G ¹ / ₄	0.18	11	6	186.00
AA-0003G	8mm / G ¹ / ₄	0.18	11	6	186.00
ACS-0003G	8mm / G ¹ / ₄	0.18	11	6	186.00
AR-0003G	8mm / G ¹ / ₄	0.18	11	6	186.00
AAR-0003G	8mm / G ¹ / ₄	0.18	11	6	186.00
AX-0003G	8mm / G ¹ / ₄	0.18	11	6	230.00

Element Code	UNIT PRICE \$
K003A0	79.00
K003AA	79.00
K003ACS	79.00
K003AR	79.00
K003AAR	79.00
K003AX	99.00

† Please state option

A0/AA/AX/ACS-0003G includes manual or constant bleed drain valve AR/AAR-0003G includes manual drain valve

MAXIGAS

Nitrogen gas generators



Don't Buy Nitrogen - Make It!

The Parker Filtration MAXIGAS range of nitrogen gas generators allows users to produce ultra high purity nitrogen gas from a supply of compressed air, without the need for high pressure cylinders or liquified gas supplies.



MAXIGAS now brings the following new advantages:

- Greater nitrogen flows
- Lower capital investment
- Increased energy efficiency
- Improved air to nitrogen ratios
- Runs off a smaller compressor for even greater energy savings
- Obtains outlet pressures up to 16 bar without a booster
- EIGA Food and Pharmacopoeia compliant
- FDA compliant

MAXIGAS has many advantages over traditional nitrogen supplies including:

- Enhanced safety without the need to store or handle high-pressure gas containers
- Reduced downtime owing to an on-demand supply
- Cost savings following payback of up to 90%
- Consistent gas flow, pressure and purity
- Compact space saving design
- Flexible modular design
- Very low cost of ownership
- No need for expensive civil works prior to installation
- Proven reliability
- Purities up to 10ppm as standard

MAXIGAS

Nitrogen gas generators



Product Selection

Performance data is based on 7 bar g (100 psi g) air inlet pressure and 20° - 25°C (66° - 77°F) ambient temperature. Consult Parker domnick hunter for performance under other specific conditions.

Oxygen Content												
Model	Unit	10ppm	100ppm	500ppm	0.1%	0.5%	1.0%	2.0%	3.0%	4.0%	5.0%	Unit Price
MAXIGAS104	m ³ /hr	2	3.2	8.1	9	14.1	17.8	22	25.8	29	32.2	P.O.A.
	cfm	1.2	1.9	4.8	5.3	8.3	10.5	12.9	15.2	17.1	19.0	P.O.A.
MAXIGAS106	m ³ /hr	3	4.8	12.1	13.4	21.2	26.6	32.8	38.7	43.5	48.3	P.O.A.
	cfm	1.8	2.8	7.1	7.9	12.5	15.7	19.3	22.8	25.6	28.4	P.O.A.
MAXIGAS108	m ³ /hr	3.9	6.4	16.2	18	28.3	35.5	43.8	51.6	58	64.4	P.O.A.
	cfm	2.3	3.8	9.5	10.6	16.7	20.9	25.8	30.4	34.1	37.9	P.O.A.
MAXIGAS110	m ³ /hr	4.9	8	20.2	22.4	35.3	44.4	54.7	64.5	72.5	80.4	P.O.A.
	cfm	2.9	4.7	11.9	13.2	20.8	26.1	32.2	38.0	42.7	47.3	P.O.A.
MAXIGAS112	m ³ /hr	5.9	9.6	24.2	26.8	42.4	53.3	65.7	77.4	87.1	96.5	P.O.A.
	cfm	3.5	5.7	14.2	15.8	25	31.4	38.7	45.6	51.3	56.8	P.O.A.
MAXIGAS116	m ³ /hr	7.9	12.8	30.7	34	53.7	67.5	83.2	98.1	110.3	122.3	P.O.A.
	cfm	4.6	7.5	18.1	20.0	31.6	39.7	49	57.7	64.9	72.0	P.O.A.
MAXIGAS120	m ³ /hr	9.8	16	37.2	41.2	65	81.7	100.7	118.7	133.5	148	P.O.A.
	cfm	5.8	9.4	21.9	24.2	38.3	48.1	59.3	69.9	78.6	87.1	P.O.A.

Technical Data

Ambient temperature range:	5 - 50°C
Nitrogen outlet pressure:	up to 11 bar g
Min. air inlet pressure:	6 to 13 bar g
Inlet air quality:	Dewpoint: -40°C
	Particulate: <0.1 micron
	Oil: <0.01 mg/m ³
Electrical supply:	200V/1ph/50Hz or 110V/1ph/60Hz
Inlet/outlet connections:	Air G1 / Nitrogen G1/2

Weights and Dimensions

Model	Height		Width		Depth		Weight	
	mm	ins	mm	ins	mm	ins	kg	lbs
MAXIGAS104	1894	75.76	550	22	692	27.68	336	740.75
MAXIGAS106	1894	75.76	550	22	861	34.44	394	868.62
MAXIGAS108	1894	75.76	550	22	1029	41.16	488	1075.9
MAXIGAS110	1894	75.76	550	22	1198	47.92	582	1283.1
MAXIGAS112	1894	75.76	550	22	1368	54.72	676	1490.3
MAXIGAS116	1894	75.76	550	22	1765	70.6	864	1904.8
MAXIGAS120	1894	75.76	550	22	2043	81.72	1052	2319.3

MAXIGAS

Standard accessories

- Oxygen analyser for continuous monitoring of nitrogen purity
- Analogue outputs for remote monitoring
- Alarm connections



MIDIGAS

Nitrogen gas generators



Product Selection

Performance data is based on 7 bar g (100 psi g) air inlet pressure and 20° - 25°C (66° - 77°F) ambient temperature. Consult Parker domnick hunter for performance under other specific conditions.

Oxygen Content													
Model	Unit	10ppm	100ppm	250ppm	500ppm	0.1%	0.5%	1.0%	2.0%	3.0%	4.0%	5.0%	Unit Price
MIDIGAS2	m ³ /hr	0.55	1.2	1.5	1.9	2.4	3.4	4.3	5.8	7.2	8.4	9.4	P.O.A.
	cfm	0.3	0.7	0.9	1.1	1.4	2.0	2.5	3.5	4.2	4.9	5.5	P.O.A.
MIDIGAS4	m ³ /hr	1.2	2.4	3.2	3.9	4.7	6.9	8.5	11.6	14.3	16.7	18.8	P.O.A.
	cfm	0.7	1.4	1.9	2.3	2.8	4.1	5.0	6.8	8.4	9.8	11.1	P.O.A.
MIDIGAS6	m ³ /hr	1.5	3.2	4.2	5.3	6.5	9.5	11.5	15.2	18.7	21.7	24.5	P.O.A.
	cfm	0.9	1.9	2.5	3.1	3.8	5.6	6.8	8.9	11.0	12.8	14.4	P.O.A.

Technical Data

Ambient temperature range:	5 - 50°C
Nitrogen outlet pressure:	up to 11 bar g
Min. air inlet pressure:	6 to 13 bar g
Inlet air quality:	Dewpoint: -40°C
	Particulate: <0.1 micron
	Oil: <0.01 mg/m ³
Electrical supply:	230V/1ph/50Hz or 115V/1ph/60Hz
Inlet/outlet connections:	G ¹ / ₂

Weights and Dimensions

Model	Height		Width		Depth		Weight	
	mm	ins	mm	ins	mm	ins	kg	lbs
MIDIGAS2	1034	41.36	450	18	471	18.84	98	216.1
MIDIGAS4	1034	41.36	450	18	640	25.6	145	319.7
MIDIGAS6	1034	41.36	450	18	809	32.36	196	432.1

MIDIGAS

Using PSA technology, the MIDIGAS range is a compact option suitable for applications requiring small to medium flow rates and is available in 3 models.



Laboratory gases

Generate laboratory gases for all of your analytical applications.



Hydrogen

Eliminate high pressure cylinders from the laboratory by generating a continuous source of UHP hydrogen gas.

- GC-FID, NPD, FPD, TCD, ELCD, HALL
- GC-carrier gas
- Total Hydrocarbon Analysers (THA)

Nitrogen

Eliminate high pressure cylinders by producing nitrogen gas from compressed air simply and cost effectively.

- LCMS (single and multiple units)
- ICP
- ELSD
- GC-FID, ECD, NPD, AED
- GC-carrier gas
- Solvent evaporation



Zero air

Through the purification of a compressed air supply Zero Air Generators are ideal for use in FID applications.

- GC-FID, NPD, FPD
- THA

Clean dry air

Desiccant dryers to provide a constant flow of clean, dry compressed air. (Please refer to page 33)

- NMR, AA, GC, ATD, Rheometer, Sample Prep, Auto-Samplers and many other applications



CO₂ free air

Replace high pressure O₂ and N₂ cylinders with CO₂ moisture free compressed gas.

- TOC analyser
- FT-IR Purge
- Microscope Purge

LC/MS Nitrogen Generators

High Purity Lab Gas

Technical Specifications

Model	Flowrate L/min	Purity % O ₂	Connections BSP		Voltage ac	Dimensions mm			Weight kg	Unit Price
			Air inlet	Gas outlet		A	B	C		
LCMS 12-1*	12	0.5	-	1/8"	110/230	345	873	663	90	P.O.A.
LCMS 15-0	15	0.5	1/4"	1/8"	110/230	510	705	559	89	P.O.A.
LCMS 15-1*	15	0.5	-	1/8"	110/230	510	705	826	129	P.O.A.
LCMS 18-0	18	0.5	1/4"	1/8"	110/230	345	873	663	77	P.O.A.
LCMS 20-0	20	1	1/4"	1/8"	110/230	510	705	559	89	P.O.A.
LCMS 20-1*	20	1	-	1/8"	110/230	510	705	826	129	P.O.A.
LCMS 30-0	30	1	1/4"	1/8"	110/230	510	705	760	135	P.O.A.
LCMS 30-1*	30	2	-	1/8"	110/230	510	705	826	129	P.O.A.
LCMS 40-0	40	1	1/4"	1/8"	110/230	510	705	760	135	P.O.A.

* with integral compressor

LCMS 12/18

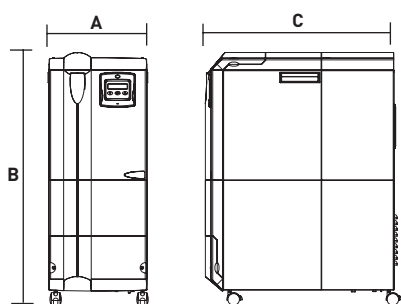

LCMS 15/20/30/40

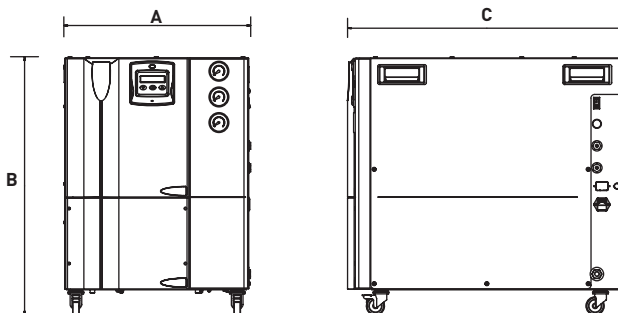

To ensure optimum performance and longevity of your LC/MS nitrogen generator, Parker domnick hunter recommends the following service kits be used as part of a preventative maintenance programme:

230 Vac Models

Model	4000 hours	8000 hours	24000 hours	Also required at 24000 hours if no compressor fitted	Unit Price
LCMS 12-1*	60 627 2354	60 627 2334	60 627 2344	-	P.O.A.
LCMS 18-0	60 627 2353	-	60 627 2342	-	P.O.A.
LCMS 15-0, 20-0, 30-0, 40-0	60 627 2251	-	60 627 2255	1 off 60 627 2257	P.O.A.
LCMS 15-1*, 20-1*, 30-1*	60 627 2251	60 627 2253	60 627 2255	-	P.O.A.

Nitrogen Generators

(Including Zero N2 and Dry Air) Produce Nitrogen gas from compressed air simply and cost effectively

Technical Specifications

Models	Flowrate L/min	Purity % O ₂	Connections BSP		Voltage Vac	Dimensions mm			Weight kg		Unit Price
			air inlet	gas outlet		A	B	C	without compressor	with compressor	
Nitrogen											
G1	0.55	10 ppm	1/8"	1/8"	110/230	345	842	413	52	56	P.O.A.
	0.75	10 ppm									
G2	1.5	10 ppm	1/8"	1/8"	110/230	345	873	663	77	90	P.O.A.
	3.0	10 ppm									
G3	2.5	100 ppm	1/8"	1/8"	110/230	345	873	663	71	83	P.O.A.
	4.0	0.1									
	5.0	0.5									
	7.0	1									
G4	8.0	2	1/8"	1/8"	110/230	345	873	663	77	90	P.O.A.
	5.0	100 ppm									
	6.0	0.1									
	10.0	0.5									
	12.5	1									
	14.0	2									
Zero Nitrogen											
G5	1.0	10 ppm	1/8"	1/8"	110/230	345	842	413	51	55	P.O.A.
N₂ & Dry Air											
G6	N2: 0.6	10 ppm	1/8"	1/8"	110/230	345	842	413	54	58	P.O.A.
	Air: 1.5	-55°C adp		1/8"							
G7	N2 : 3.0	10 ppm	1/8"	1/8"	110/230	345	873	663	80	93	P.O.A.
	Air: 3.0	-55°C adp		1/8"							
Dry Air											
G8	3.0	-55°C adp	1/8"	1/8"	110/230	345	842	413	50	54	P.O.A.
G9	6.0	-55°C adp	1/8"	1/8"	110/230	345	842	413	50	54	P.O.A.

G1/G5/G6/G8/G9 models

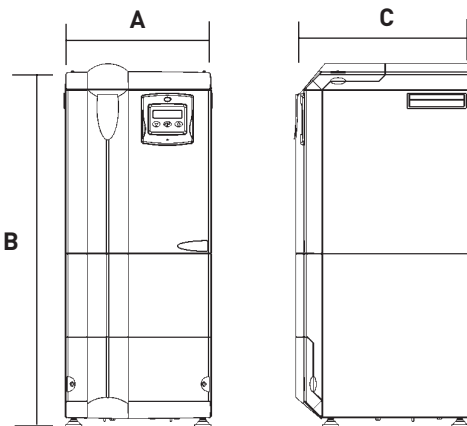

G2-G4/G7 models

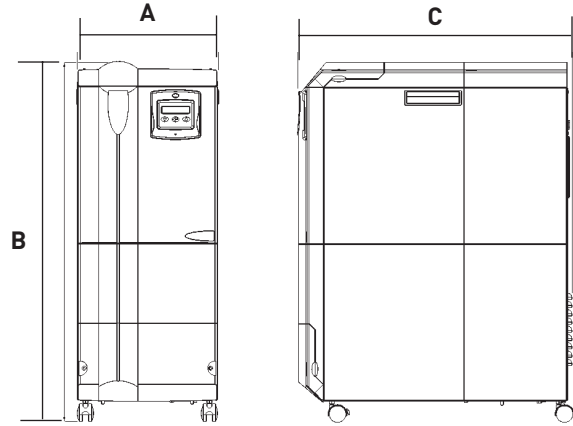

Zero Air Generators

Hydrogen Free

Technical Information

Parker domnick hunter zero air generators use a combination of Parker domnick hunter OIL-X EVOLUTION high performance filtration and catalytic technologies to purify an existing compressed air supply.

The compressed air passes first through a high efficiency OIL-X EVOLUTION grade AO filter to ensure removal of oil,

water and particulate. The clean compressed air then enters the catalyst unit where hydrocarbons are oxidised to water and carbon dioxide.

Finally, a high efficiency OIL-X EVOLUTION grade AA 0.01 micron filter removes any remaining particulate. The Parker domnick hunter zero air

generator employs air temperature monitoring inside the catalyst unit to reliably maintain the optimum operating temperature and ensure high performance hydrocarbon removal. Inlet design further enhances efficiency by ensuring balanced air flow through the catalyst unit.

Technical Specifications

Model	Flow rate L/min	Purity/total hydrocarbon content	Connections		Voltage ac	Dimensions mm			Weight kg	Unit Price
			Air inlet	Air outlet		H	W	D		
UHP-10ZA-S	1.0	<0.1 ppm	1/8"	1/8"	115/230	325	340	425	10.8	P.O.A.
UHP-35ZA-S	3.5	<0.1 ppm	1/8"	1/8"	115/230	455	340	425	10.8	P.O.A.
UHP-50ZA-S	5.0	<0.1 ppm	1/4"	1/4"	115/230	455	340	425	16.1	P.O.A.
UHP-75ZA-S	7.5	<0.1 ppm	1/4"	1/4"	115/230	455	340	425	16.1	P.O.A.
UHP-150ZA-S	15.0	<0.1 ppm	1/4"	1/4"	115/230	455	340	425	16.1	P.O.A.
UHP-200ZA-S	20.0	<0.1 ppm	1/4"	1/4"	115/230	455	340	425	16.1	P.O.A.
UHP-300ZA-S	30.0	<0.1 ppm	1/4"	1/4"	115/230	455	340	425	16.1	P.O.A.

UHP-10ZA-S

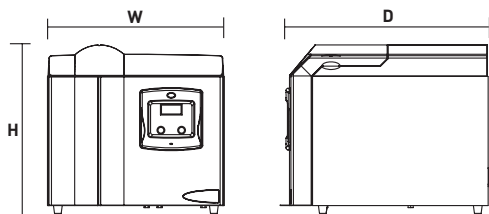

UHP-35ZA-S to UHP-300ZA-S

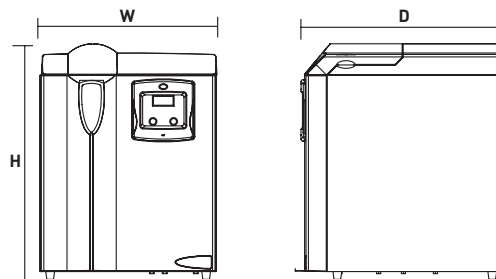

To ensure optimum performance and longevity of your zero air generator, Parker domnick hunter recommends the following filter changes every 12 months:

Model	UHP-10ZA-S	UHP-35ZA-S	UHP-50ZA-S	UHP-75ZA-S	UHP-150ZA-S	UHP-200ZA-S	UHP-300ZA-S	Unit Price
Inlet Air Filter Element	005 AO	005 AO	005 AO	005 AO	005 AO	005 AO	005 AO	P.O.A.
Outlet Air Filter Element	005 AA	005 AA	005 AA	005 AA	005 AA	005 AA	005 AA	P.O.A.

Hydrogen Generators

Technical Information

Parker domnick hunterhigh purity hydrogen generators use an ion exchange membrane to produce a flow of ultra-pure hydrogen. Use of the electrolytic dissociation process enables water to be broken down into hydrogen and oxygen. The oxygen is released into the air, while the hydrogen is retained to form the product flow.

A long-life desiccant cartridge purifies the hydrogen even further so that it attains the desired grade of purity and ensures constant reproducible results.

As it only uses de-ionized water and electricity, continuous operation is assured.

Having proven its worth in thousands of systems worldwide, this technology eliminates the need to use liquid electrolytes, such as caustic solutions.

Technical Specifications

Models	Flowrate ml/min	Purity %	Pressure	Connections BSP H ₂ outlet	Voltage Vac	Electrical Consumption	Dimensions mm						Weight kg	Unit Price
							A	B	C	D	E	F		
20H	160	99.999	0-7 bar (0-100 psi)	1/8" Swagelok	110-230	125w	342	456	437	108	109	645	24	P.O.A.
40H	250	99.999	0-7 bar (0-100 psi)	1/8" Swagelok	110-230	185w	342	456	437	108	109	645	24	P.O.A.
60H	500	99.999	0-7 bar (0-100 psi)	1/8" Swagelok	110-230	235w	342	456	437	108	109	645	24	P.O.A.

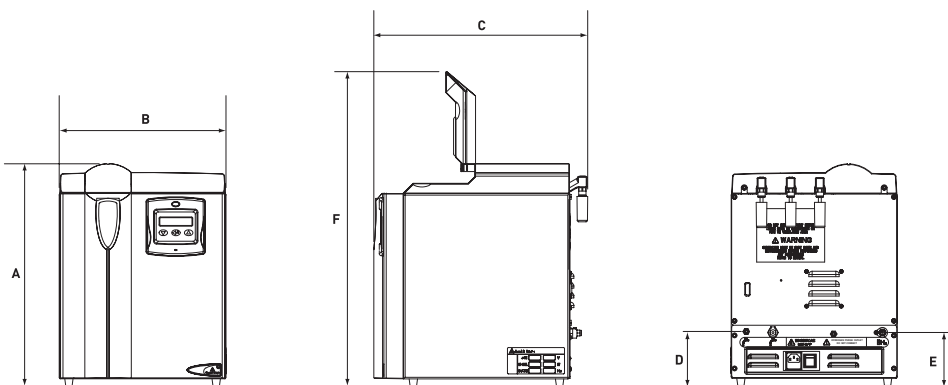

To ensure optimum performance and longevity of your H range hydrogen generator, Parker domnick hunter recommends the following preventative maintenance kits:

Description	Part Number	Change Interval
Desiccant cartridge	60 497 0412	See note #1
6 month preventative maintenance kit	60 497 0600	6 months
24 month preventative maintenance kit	60 497 0532	24 months

Note #1: Desiccant Cartridge Replacement:
Change interval dependent on generator model and operating regime.

The following optional accessories are available for use with Parker domnick hunter h range hydrogen generators:

Description	Part Number
High purity oxygen / moisture trap	60 497 0598
Options board kit	60 497 0722

MD Hydrogen Generators

Technical Information

Parker domnick hunter high purity hydrogen generators use an ion exchange membrane to produce a flow of ultra-pure hydrogen. Use of the electrolytic dissociation process

enables water to be broken down into hydrogen and oxygen. The oxygen is released into the air, while the hydrogen is retained to form the product flow.

A regenerative desiccant dryer then purifies the hydrogen further making it suitable for use as GC or GC/MS carrier gas.

Technical Specifications

Model	Flowrate ml/min	Purity %	Pressure	Connections BSP H ₂ outlet	Voltage Vac	Electrical Consumption	Dimensions mm						Weight kg	Unit Price
							A	B	C	D	E	F		
20H-MD	160	99.9999	0-7 bar (0-100 psi)	1/8" Swagelok	110 - 230	180W	342	456	437	108	109	645	28	P.O.A.
40H-MD	250	99.9999	0-7 bar (0-100 psi)	1/8" Swagelok	110 - 230	210W	342	456	437	108	109	645	28	P.O.A.
60H-MD	500	99.9999	0-7 bar (0-100 psi)	1/8" Swagelok	110 - 230	300W	342	456	437	108	109	645	28	P.O.A.
110H-MD	1000	99.9999	0-7 bar (0-100 psi)	1/8" Swagelok	110 - 230	600W	342	456	437	108	109	645	30	P.O.A.

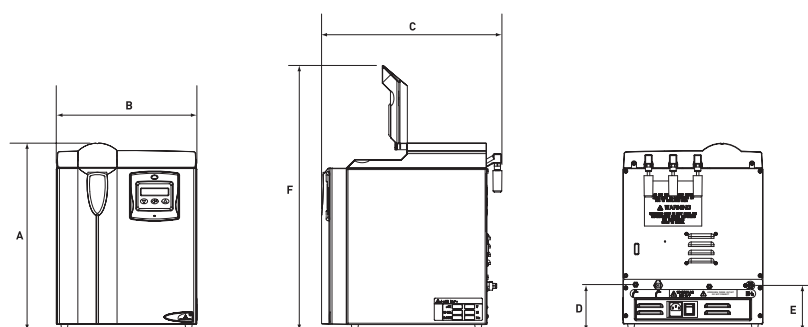

To ensure optimum performance and longevity of your H-MD Hydrogen generator, Parker domnick hunter recommends the following preventative maintenance kits:

Description	Part Number	Change Interval
6 month preventative maintenance kit	60 497 0600	6 months
24 month preventative maintenance kit	60 497 0720	24 months

The following accessories and installation kits are available to complement the Parker domnick hunter H-MD range of laboratory hydrogen generators.

Description	Part Number	
	1/8" Tube	1/4" Tube
Isolation valve	604970700	604970713
Flow controller 0-300cc/min		604970701*
Flow controller 0-600cc/min		604970702*
Flow controller 0-1200cc/min		604970703*
Non-return valve	604970704	604970714
Pressure relief valve	604970707	604970717
Port Reducing connector		604970708
Standard regulator		604970709*

Description	Part Number
Options board Kit	60 497 0722

*Port reducing connector (part number 604970708) required if 1/4" tubing used.

C02 Free Generators

Technical Information

Water and CO₂ levels inside an FT-IR spectrometer vary according to changes in the CO₂ and water content of the laboratory air. Something as simple as the number of people in the laboratory, or whether a window is open or closed, can lead to changes in background spectral absorbances from one scan to the next.

The supply of CO₂ free air to the air bearing interferometer chamber ensures that the levels of carbon dioxide and water are maintained at constant, low levels thereby eliminating changes in spectral absorbances. Purging of the spectrometer body with CO₂ free air also retards the degradation of the

beamsplitter through attack by moisture. The result is increased accuracy of analyses and improved instrument reliability.

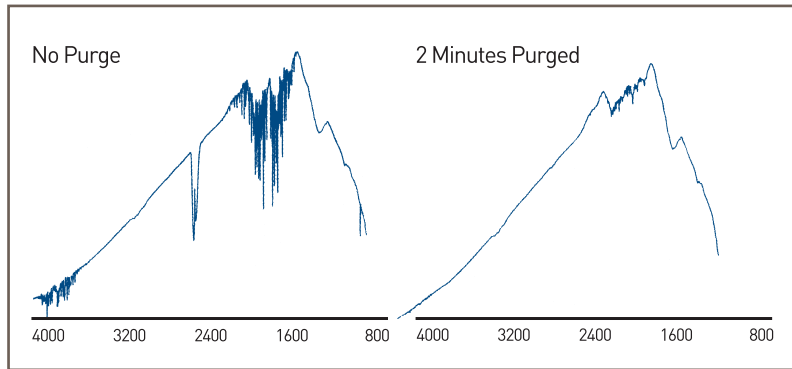

Technical Specifications

Models	Flowrate L/min	Minimum Inlet Pressure	Maximum Inlet Pressure	Voltage Vac	Dimensions mm			Weight kg	Unit Price
					A	B	C		
CO2RP015	1.5	4barg	10.5barg	110/230	310	380	90	8	P.O.A.
CO2RP140	14	4barg	10.5barg	110/230	310	470	90	10	P.O.A.
CO2RP280	28	4barg	10.5barg	110/230	310	710	90	12	P.O.A.
CO2RP850	85	4barg	10.5barg	110/230	420	1020	150	36	P.O.A.

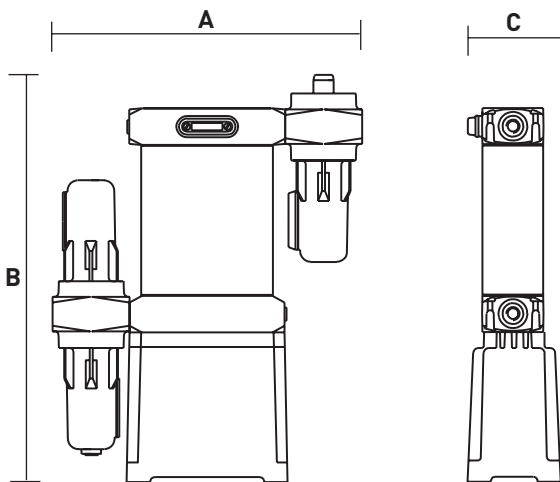

Air Purity

Max. Working pressure:	10.5 barg
CO ₂ Content:	<1ppm
Pressure dewpoint:	-70°C (-100°F)
Purity:	Non-methane HC's <0.003 ppm particles <1.0 micron

NitroFlow® Basic

Most reliable & low running cost nitrogen unit due to special Parker-principle



Features

- Only requires electrical power in order to produce nitrogen
- Unlimited nitrogen supply
- Nitrogen purity 93% to 99.9%
- Capacity up to 50 Nlpm
- Oxygen indicator included
- Minimal maintenance
- Low and high nitrogen pressure available
- Mobile and wall-mounted versions
- Wall-mount gas Mix Add-on for N₂-CO₂ mixture

Product description

Parker nitrogen generators are based on Parker hollow fibre membrane technology, which makes it possible to separate air into nitrogen and an oxygen-enriched stream.

NitroFlow Basic covers a range of models each with its built-in compressor system, so you can produce nitrogen from ambient air simply by connecting to a mains voltage power source.

The Mix Add-on for the wall-mounted version incorporates a gas blender, which enables you to produce nitrogen-CO₂ blends using an external source of CO₂.

A unique process and system design eliminates the need for condensed water removal and draining, ensuring the longest compressor and membrane life. Both low and high pressure nitrogen generation is possible. Using low pressure when no pressure is needed and opting for high

pressure when this is required or when nitrogen storage is needed. An optional additional storage vessel enables variable or peak consumption to be handled. NitroFlow Basic will automatically switch on and off, depending on the nitrogen demand from the storage vessel.

With low running costs, NitroFlow Basic offers an unlimited and reliable source of nitrogen with virtually no maintenance.

Mobile unit

- Compact unit - even fits under a desk
- Easy to move around

Wall Mounted Unit

- Compact design
- O₂ indicator included
- Ready to connect to a nitrogen storage vessel

Wall Mounted Mix Add-on

- Two nitrogen-CO₂ blends produced simultaneously
- Ultimate flexibility. Mix Add-on can be placed left, right or underneath the NitroFlow Basic

Integrated compressors

- Both low pressure and high pressure possible
- Maximum compressor life due to low pressure nitrogen generation
- Optimised heat-management
- Silent design

Easy operation

- Plug and play. Stand alone unit - no compressed air source required
- One man installation
- Easy wall-bracket mounting

Maintenance

- Easy access
- Only 1 carbon adsorber inlet filter
- Easy compressor change-out
- Lowest maintenance cost of any generator

Specifications

Minimum nitrogen production capacity

Capacity [Nlpm] at nominal conditions: ambient temperature 20°C, ambient pressure 1013 mbar(a)

Low Pressure (LP) max. 2 bar(g) nitrogen pressure

Nitrogen purity %	99.9	99.7	99.5	99	98	97	96	95	93
Nlpm	10	15	18	24	31	35	40	43	50

High Pressure (HP) max. 8 bar(g) nitrogen pressure

Nitrogen purity %	99.9	99.7	99.5	99	98	97	96	95	93
Nlpm	7.6	12	13	18	23	26	30	32	38

Calculation of overall mix gas capacity when using the NitroFlow Basic HP Mix option

Multiply the nitrogen capacity by the conversion factor given below

CO ₂ percentage	10	20	30	40	50	60	70
Conversion factor	1.11	1.25	1.42	1.67	2.0	2.5	3.33

Technical data

Data/Type generator	NF Basic LP Mobile	NF Basic HP Mobile	NF Basic LP Wall-Mounted	NF Basic HP Wall-Mounted	NF Basic HP Wall-Mounted + Mix Add-on
Max. delivery pressure	2.0 bar(g)	8.0 bar(g)	2.0 bar(g)	8.0 bar(g)	7 bar(g) mix-gas
Air quality	Normal clean ambient air - relative humidity: < 90%				
Temperature	10 - 35 °C				
Connections	Nitrogen and permeate outlet: G1/4 - 1/4 NPT"				
Noise level	< 58 dBA		< 65 dBA		
Electrical data	Available as 120Vac/60Hz - 230Vac/50Hz				
Power consumption	1.4 kW				
Output signals	Oxygen %, outlet pressure: analogue 4-20 mA - Alarm: potential free relay (max. 25V)				
Input	Digital input: switch on/off				
Dimensions (HxWxD)	700 x 900 x 310 mm		775 x 380 x 380 mm		depends on position Mix Add-on
Weight	92.5 kg		75 kg		80 kg

Part numbers	NF Basic LP Mobile	NF Basic HP Mobile	NF Basic LP Wall-Mounted	NF Basic HP Wall-Mounted
120 Vac / 60 Hz	159.003727	159.003364	159.003731	159.003735
230 Vac / 50 Hz	159.003728	159.003340	159.003732	159.003736
Maintenance kits - yearly	159.003754			
Oxygen transmitter	159.002284 - replace once every 3 years			

Position Mix Add-on	Left	Right	Under
NitroFlow Mix Add-on	159.003755	159.003756	159.003832

Reference condition for Nlpm = 20°C and 1013 mbar(a)

Parker Filtration & Separation B.V. has a continuous policy of product development and although the company reserved the right to change specifications, it attempts to keep customers informed of any alterations. This publication is for general information only and customers are requested to contact your Parker sales representative for detailed information and advice on a products suitability for specific applications. All products are sold subject to the company's standard conditions of sales.

NitroFlow®

Mid-size generator range



Features

- Available as low pressure (LP) and high pressure (HP) versions
- NitroFlow LP requires only electrical power in order to produce nitrogen
- NitroFlow HP can work with an existing central compressed air system or dedicated compressor
- Unlimited nitrogen supply
- Minimal maintenance
- Touch screen interface
- Easy installation

Product description

Parker nitrogen generators are based on Parker hollow fibre membrane technology, which makes it possible to separate air into nitrogen and an oxygen-enriched stream.

NitroFlow is available in both low pressure (LP) and high pressure (HP) ranges. Using NitroFlow LP when no pressure is needed and opting for NitroFlow HP when the application requires for high pressure or when nitrogen storage is needed.

The NitroFlow LP range has built-in compressors to produce nitrogen from ambient air simply by connecting to a main voltage power source. A unique process and system design eliminates the need for condensed water removal and draining, ensuring the longest compressor and membrane life.

The NitroFlow HP range requires compressed air either from a central system, or from a dedicated compressor. An optional additional storage vessel enables variable or peak consumption to be handled.

NitroFlow will automatically switch on and off, depending on the nitrogen demand. With low running costs, NitroFlow offers an unlimited, virtually maintenance-free and reliable source of nitrogen.

NitroFlow LP unit

- Integrated compressors
- Low pressure nitrogen up to 2 bar(g)
- Plug and play
- Silent and vibration free
- No condensate formed

NitroFlow HP unit

- High quality integrated compressed air filtration
- Works with standard compressed air house system 7 bar(g) or dedicated compressor
- Modular design, unit can grow with your factory

Touch screen interface

- Easy user interface
- Extensive alarm and datalog functions
- Remote control option
- Data communication
- Multi-language operation

Modern design

- Robust construction
- Digital interface
- Easily expandable

Easy installation

- Connect power source
- Connect air supply
- Vent permeate
- Fork-lift truck access points

Maintenance

- Easy access
- Maintenance indication
- Yearly filter exchange
- Compressor requires no maintenance

Specifications

Minimum nitrogen production capacity

Capacity [Nm³/hr] at nominal conditions: ambient temperature 20°C, ambient pressure 1013 mbar(a)

NitroFlow LP with built-in compressors

Nitrogen purity %	99.5%	99%	98%	97%	96%	95%	93%
NitroFlow LP 1	1.1	1.5	2.2	2.7	3.1	3.5	4.1
NitroFlow LP 2	2.2	3.0	4.5	5.3	6.0	6.8	8.0
NitroFlow LP 3	3.4	5.3	6.6	7.8	9.0	10.2	12.2
NitroFlow LP 4				10.3	12.0	13.6	16.4

NitroFlow HP for connection to external compressed air supply at 7 bar(g) nominal inlet pressure

Nitrogen purity %	99.5	99	98	97	96	95
NitroFlow HP 1	1.7	2.5	3.8	5.0	6.3	7.5
NitroFlow HP 2	3.4	5.0	7.6	10.0	12.6	15.0
NitroFlow HP 3	5.1	7.5	11.4	15.0	18.9	22.5

For calculation of the capacity of the NitroFlow HP at feed pressures other than the nominal feedpressure: multiply the nominal capacity by the correction factor for the pressure at the inlet of the NitroFlow HP.

Pressure bar(g)	5	6	7	8	9	10	11	12	13
Correction factor	0.65	0.8	1	1.15	1.3	1.5	1.65	1.8	2

Technical data

Data/Generator	LP1	LP2	LP3	LP4	HP1	HP2	HP3
Max. delivery pressure	2.0 bar(g)				Inlet pressure minus pressure drop (2 bar max.)		
Air quality	Normal clean ambient air – relative humidity: < 90%				Residual oil content < 3.0 mg / m ³ Pressure dewpoint < 5°C		
Temperature	10 – 35°C				10 – 40°C		
Connections	Nitrogen and permeate outlet: 1"				Air inlet, nitrogen and permeate outlet: 1"		
Noise level	< 65 dBA				< 45 dBA		
Electrical data	230 Vac 1ph/50 Hz		400 Vac 3ph+N+PE/50 Hz		120-230 Vac 1ph/50-60 Hz		
Power consumption	1.7 kW	3.2 kW	4.8 kW	6.3 kW	30 W		
Output signals	Oxygen %, outlet pressure: analogue 4-20 mA – Alarm: potential free relay (max. 25 V)						
Input	Digital input: switch on/off						
Dimensions	1224 x 725 x 540 mm		1224 x 725 x 810 mm		1224 x 725 x 270 mm		
Weight	150 kg	200 kg	320 kg	370 kg	85 kg	95 kg	105 kg

	LP1	LP2	LP3	LP4	HP1	HP2	HP3
Part numbers	99.5% - 99%	99.5% - 99%	99.5%	159.004031	159.004032	159.004033	159.004034
	159.004537	159.004538	159.004539				
	98% - 93%	98% - 93%	99% - 93%				
	159.004028	159.004029	159.004030				
Maintenance kits – yearly	159.004425				159.004045		
Oxygen transmitter	159.002284 - replace every 3 years						

Reference condition for Nm³ = 20°C and 1013 mbar(a)

Parker Filtration & Separation B.V. has a continuous policy of product development and although the company reserved the right to change specifications, it attempts to keep customers informed of any alterations. This publication is for general information only and customers are requested to contact your Parker sales representative for detailed information and advice on a products suitability for specific applications. All products are sold subject to the company's standard conditions of sales.

NitroSource®

Capacity up to 5000 Nm³/hr



Features

- Produces nitrogen from compressed air
- Can operate with existing central compressed air system
- Nitrogen purity up to 99.5%
- Capacity up to 5000 Nm³/hr
- Compressed air pre-treatment section included
- Minimum maintenance
- Digital data management
- Easy to expand
- Modular design

Product description

Parker nitrogen generators are based on Parker hollow fibre membrane technology, which makes it possible to separate air into nitrogen and an oxygen-enriched air stream. The NitroSource industrial nitrogen generator easily enables you to produce nitrogen from compressed air.

The NitroSource consists of a main-unit that can be expanded with a maximum of 5 additional subunits. Thanks to the master/slave feature, up to 11 main-units

and their sub-units can be connected and controlled as one generator. The NitroSource includes a high quality compressed air filtration stage.

This optimises the inlet compressed air quality, ensuring long membrane life. The generator is equipped with a digital data management system to monitor, store and communicate parameters such as pressure, flow and residual oxygen concentration.

The installation has virtually no moving parts, resulting in reliable,

trouble free operation with almost no maintenance. The generator is ready to operate as soon as the compressed air supply is connected.

The NitroSource offers an unlimited supply of nitrogen and can be connected to an external storage vessel. This will ensure that the system is able to cope with peak demand in applications where the nitrogen demand is variable.

Main-unit

- Robust industrial design
- Compact and modern
- High quality pre-filtration stage

Sub-unit

- Nitrogen modules
- Individual filtration
- Easy to add to existing NitroSource

Master/slave option

- 11 main-units each with up to 5 sub-units can function as one generator
- Back-up option
- Multiple main-units equally used
- Data management and control via master unit

Digital data management

- Data logging
- Status information
- System set-up information
- Maintenance indication
- Extensive data exchange facilities
- Detailed alarm functions
- Remote control option

Global design

- Multi-language operation
- Universal power supply
- Choice of measurement units

Easily expandable

- Modular construction
- Easy to connect
- Up to 5 sub-units per main-unit

Easy start-up

- Connect air supply
- Connect power
- Vent permeate
- Easy set-up wizard

Maintenance

- Easy access
- Only occasional filter exchange required
- Fork-lift truck access points

Specifications

Minimum nitrogen production capacity

Capacity [Nm³/hr] at nominal conditions: ambient temperature 20°C, ambient pressure 1013 mbar(a).

Inlet pressure 7 bar(g)

Nitrogen purity %	99.5	99	98	97	96	95
Capacity per unit in Nm ³ /hr	6.0	9.4	16.2	22	28	34
Main-unit	6.0	9.4	16.2	22	28	34
Main-unit + 1 sub-unit	12.0	18.8	32.4	44	56	68
Main-unit + 2 sub-units	18.0	28.2	48.6	66	84	102
Main-unit + 3 sub-units	24.0	37.6	64.8	88	112	136
Main-unit + 4 sub-units	30.0	47.0	81.0	110	140	170
Main-unit + 5 sub-units	36.0	56.4	97.2	132	168	204

For calculation of the capacity at feed pressures other than the nominal feed pressure: multiply the nominal capacity by the correction factor for the pressure at the inlet of the NitroSource.

Pressure bar(g)	4	5	6	7	8	9	10	11	12	13
Correction factor	0.35	0.51	0.76	1.00	1.20	1.40	1.60	1.90	2.10	2.40

Technical data

Data/NitroSource Unit	NitroSource Main-unit	NitroSource Sub-unit
Max. delivery pressure	Inlet pressure minus pressure drop (2 bar max.)	
Max. feed pressure	13 bar(g)	
Temperature	10-40°C	
Residual oil content	< 3.0 mg/m ³	
Pressure dew point	< 5°C	
Noise level	< 45 dB(A)	
Connections	Air inlet: G 1¼" - Outlet G 1" - Permeate vent: 110 mm	Nitrogen outlet: G 1" - Permeate vent: 110 mm
Electrical data	90-250 VAC/50-60 Hz	
Output signals	0 - 10 volt: oxygen, inlet pressure, flow rate (optional) RS232: datalogging Potential free relay: compressor start/stop, alarm, drain	
Input	Digital input: switch on/off	
Dimensions (HxWxD)	1928 x 725 x 490 mm	1928 x 725 x 270 mm
Weight	180 kg	95 kg

	NitroSource Main-unit	NitroSource Sub-unit
Part numbers	159.003552	159.003553
Maintenance kits - yearly	159.003569	159.003570
Oxygen transmitter	159.002284 - replace once every 3 years	

Reference condition for Nm³ = 20°C and 1013 mbar(a)

Parker Filtration & Separation B.V. has a continuous policy of product development and although the company reserved the right to change specifications, it attempts to keep customers informed of any alterations. This publication is for general information only and customers are requested to contact your Parker sales representative for detailed information and advice on a products suitability for specific applications. All products are sold subject to the company's standard conditions of sales.



Process Filtration

...providing complete filtration solutions

domnick hunter Process Filtration specialises in the manufacture and supply of high quality products for the clarification, stabilisation and sterilisation of liquids and gases, providing full scalability from membrane flat stock discs to multi-element filter systems. Each filter range has been specifically developed for industry requirements.

We have a vast range of filtration experience enabling us to provide innovative and cost effective solutions for all your filtration requirements.

domnick hunter's commitment to service is reflected in our comprehensive before and after sales service.

Our worldwide assistance extends to on-site evaluations, design, manufacture, validation, quality control and ongoing support long after the filters are installed.

We supply the best products for you, when and where you need them.

We have a vast range of filtration experience enabling us to provide cost effective solutions to all your filtration requirements. We have the capability to work across application areas including:

- Biopharmaceutical
- Beverage
- Chemical
- Electronics
- Fermentation
- Food and Dairy
- Healthcare and Cosmetics
- Hospitals
- Paints and Inks
- Petrochemical



Process Chiller

Precision chilled water



WHY AN INDUSTRIAL CHILLER?

The use of cold water is very common in industry. The motives are obvious: cold water improves productivity, secures industrial processes and reduces costs. There are several methods of creating cold water, but water chillers are increasingly becoming the preferred solution. But why? Firstly, chillers always supply the exact water temperature requested, even with differing ambient conditions and differing load requests, thus ensuring optimum efficiency. Water has furthermore become a very precious, and costly, natural resource. Chillers, by operating in a closed circuit, continuously reuse the same water, and thereby avoid unwanted water wastages. Add to this the fact that a number of directives have recently emerged to safeguard both the quality of the water being utilised (for health reasons) as well as the discharging of impure water into the ambient (to protect the environment): closed circuit chiller operation greatly simplifies conformance to these regulations. The needs of industry are changing, and a water chiller increasingly satisfies these needs.

APPLICATIONS

- **Food** (drinks, confectionery, processing, storage)
- **Plastics** (injection, blow moulding, extrusion, film extrusion, thermoforming)
- **Lasers** (welding, profiling, cutting, optics, medical, aesthetics)
- **Paper** (manufacture, printing, cardboard, labels, plastic film)
- **Chemical** (petrochemical, paints, solvents, temperature control)
- **Air conditioning** (civil, industrial, process)
- **Mechanical** (welding, cutting, profiling, polishing, rolling)
- **Other** (wood, ceramics, gold & silver, pharmaceutical, compressed air, textile)

BENEFITS

- **Increases productivity, reduces costs**
- **Optimises industrial applications**
- **Adaptable to individual customer needs**
- **Accepts a range of temperatures & flows**

Model	Cooling capacity (kW) ¹		Flow m ³ /h		Tank Capacity Litres	Pipe size	Dimensions (mm)			Weight	UNIT PRICE \$
	Air Cooled	Water Cooled	Nom	Max			DEPTH	WIDTH	HEIGHT		
ICE003	2.5	N/A	0.2/2.4	25	25	1"	530	750	800	105	P.O.A.
ICE005	5.1	N/A	0.8/2.4	25	25	1"	530	750	800	110	P.O.A.
ICE007	7	N/A	1.3/3	45	45	1"	980	534	1228	170	P.O.A.
ICE010	9.5	N/A	1.5/3	45	45	1"	980	534	1228	180	P.O.A.
ICE015	14.3	ON REQUEST	2.3/6	120	120	1 1/4"	1122	730	1358	250	P.O.A.
ICE022	21.8	ON REQUEST	3.5/9.6	120	120	1 1/4"	1122	730	1358	270	P.O.A.
ICE029	28.1	29.6	4.5/9.6	180	180	1 1/2"	1650	744	1358	380	P.O.A.
ICE039	38.2	39.5	6.3/9.6	180	180	1 1/2"	1650	744	1358	410	P.O.A.
ICE046	45.2	47.6	7.6/18	250	250	1 1/2"	1650	744	1358	430	P.O.A.
ICE057	56.4	59	9.3/18	300	300	1 1/2"	2200	744	1358	520	P.O.A.
ICE076	76	79.8	13/18	500	500	2"	2200	898	1954	800	P.O.A.
ICE090	90.2	97.5	15/26	500	500	2"	2200	898	1954	900	P.O.A.
ICE116	115.5	120.1	19/27	500	500	2"	2200	898	1954	1000	P.O.A.
ICE150	149.2	156.7	25/50	1000	1000	2 1/2"	3000	1290	2272	1500	P.O.A.
ICE183	182.3	195	30/50	1000	1000	2 1/2"	3000	1290	2272	1800	P.O.A.
ICE230	227.9	ON REQUEST	39/48	1000	1000	2 1/2"	3270	1290	2272	2100	P.O.A.
ICE310	309.1	N/A	52/90	400	400	4"	4210	1510	2238	2900	P.O.A.
ICE360	359.7	N/A	62/90	400	400	4"	4210	1510	2238	3100	P.O.A.

SUITED TO ALL OPERATING CONDITIONS

Hyperchill standardly accepts water inlet temperatures up to 30°C, and delivers outlet temperatures down to 0°C *. Inlet/outlet temperature differences of as much as 15°C can be obtained. Hyperchill operates with ambient temperatures up to 45°C, even with high water temperatures and during start-up. Models from ICE007 can be installed outdoors. The water by-pass (standard on ICE005-230) guarantees fault-free operation with fluctuating water flows and facilitates chiller start-up. (* with water/glycol mixtures)

Correction factors for the calculation of the cooling capacity

A)	Ambient temp. (air cooled models)	°C	5	10	15	20	25	30	35	40	45
	Correction factor		1.05	1.05	1.05	1.05	1	0.95	0.89	0.83	0.77
B)	Water outlet temp.	°C	5		10		15		20		25
	Correction factor		0.72		0.86		1		1		1
C)	Glycol (in weight)	%		10		20		30		40	50
	Correction factor			0.99		0.98		0.97		0.1	0.94
D)	Condenser H2O inlet temp (water cooled)	°C	20		25		30		35		40
	Correction factor		1		0.95		0.9		0.85		0.8

To obtain the required cooling capacity of the required chiller, multiply the value at nominal conditions by the above correction factors (i.e. cooling capacity = PxAxBxCxD, where P is the cooling capacity) to get the sized capacity. ICE, in its standard configuration, can operate up to ambient temperatures of max 45°C and min. 5°C and water temperatures of max. 30°C inlet and min.0°C outlet. The above correction factors are approximation only: for a precise selection always refer to the software selection program.



Compressed Air Hollow Fiber Membrane Dryers

Bulletin 1300 - 800/USA



Dryers

Finite®

FMD-Series Hollow Fiber Membrane Technology

Finite®, the world leader in coalescing media development, has combined its proven coalescing filtration with a modern alternative to pressure swing and refrigerant dryer technologies.

Finite®'s membrane dryers are available in 10 models which can supply clean, dry compressed air with dewpoints as low as -40°F (@10 SCFM) and +35° F (@40 SCFM).

These membrane dryers are engineered for easy installation, minimal maintenance, and long term reliability.

How It Works:

The water vapor in the compressed air is removed by the principle of selective permeation through a membrane. The membrane module consists of bundles of hollow membrane fibers, each permeable to water vapor. As the compressed air passes through the center of these fibers, water vapor permeates through the walls of the fiber. A small portion of the dry air (purge flow) is redirected along the outside of each hollow fiber, carrying away the moisture-laden air which is then exhausted to room atmosphere. The remainder of the dry air is piped to the application.

NOTE: In all cases a Grade 10 prefilter and a Grade 6 coalescer are installed upstream of the dryer module for 99.9985% removal of oil aerosols and mists.

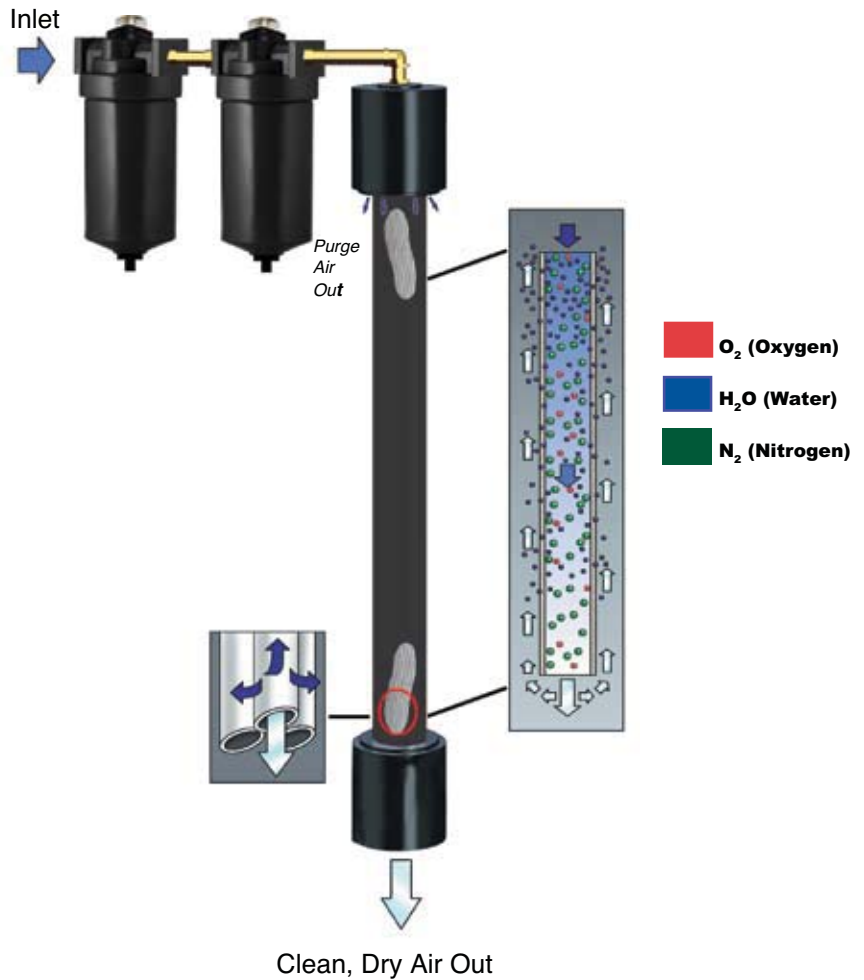

Applications

- Air bearings
- Analytical instrumentation
- Coordinate measurement machines (CMM)
- Dental air
- Dry air for hazardous areas
- Electrostatic painting
- General laboratory air supply
- Laboratory grade air
- Laser and optical purge
- Low dewpoint instrument air
- OEM machine builders
- Pneumatic equipment
- Prevention of air line freeze ups
- Purge air for electronic cabinets
- Purge air for moisture sensitive coatings and adhesives

Features

- No moving parts
- Quiet
- Designed for point of use
- Continuous operation
- Differential pressure indicator (on selected models)
- Hollow fiber technology
- Non oxygen depleting membrane fibers

Advantages

- Nothing to wear out
- Can be installed anywhere
- Lightweight
- No waiting for media changeouts
- Indicates when filter element should be changed
- No electricity
- No U.L. approval required
- No refrigerants
- Low dewpoints
- Only water vapor molecules are allowed to pass through fiber walls

Benefits

- Less downtime
- Perfect for point-of-use applications
- Ease of installation
- Less downtime
- Dryer protection insurance
- Low operating cost
- OEM cost savings
- Environmentally friendly
- Prevents freezing
- Dryers can be used in medical, dental and breathing air applications

+35° F Dewpoint Dryers

Part Number FMD35-006

Specifications:

Width	5.5" (14.00 cm)
Height	14.5" (36.83 cm)
Port Size	1/4" NPT
Min./Max. Inlet Pressure	60/150 PSIG (4.1-10.3 bar)
Ambient/Inlet Temp. Range	40°-100° F (4.4°-37.8° C)
Purge Flow @ 100 PSI	0.25 SCFM (0.43 NM ³ /H)
Pre-coalescer Part #	Q1S-10HM06-013
Replacement element:	10HM06-013
Coalescer Part #	Q1S-6HM06-013
Replacement element:	6HM06-013

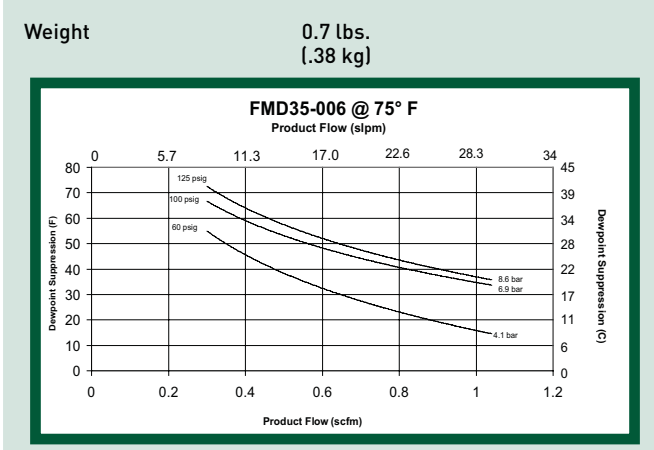
Total Air Consumption = Purge Flow + Product Flow

+35° F Dewpoint Dryers

Part Number FMD35-015

Specifications:

Width	6.5" (16.51 cm)
Height	15" (38.10 cm)
Port Size	1/4" NPT
Min./Max. Inlet Pressure	60/150 PSIG (4.1-10.3 bar)
Ambient/Inlet Temp. Range	40°-100° F (4.4°-37.8° C)
Purge Flow @ 100 PSI	0.5 SCFM (0.85 NM ³ /H)
Pre-coalescer Part #	Q1S-10HM06-013
Replacement element:	10HM06-013
Coalescer Part #	Q1S-6HM06-013
Replacement element:	6HM06-013

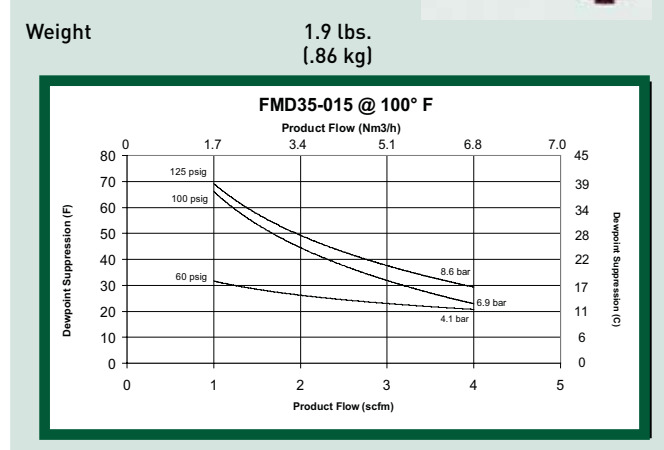
Total Air Consumption = Purge Flow + Product Flow

Dryers

Part Number FMD35-060

Specifications:

Width	10" (25.4 cm)
Height	22" (55.88 cm)
Port Size	1/4" NPT
Min./Max. Inlet Pressure	60/150 PSIG (4.1-10.3 bar)
Ambient/Inlet Temp. Range	40°-100° F (4.4°-37.8° C)
Purge Flow @ 100 PSI	1.5 SCFM (2.55 NM³/H)
Pre-coalescer Part #	HN1S-10CW
Replacement element:	10C10-025
Coalescer Part #	HN1S-6CW
Replacement element:	6C10-025
Weight	5.2 lbs. (2.36 kg)

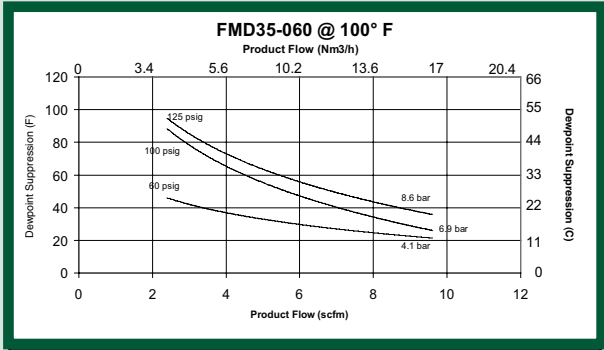

Total Air Consumption = Purge Flow + Product Flow

Part Number FMD35-100

Specifications:

Width	11.5" (29.21 cm)
Height	22" (55.88 cm)
Port Size	1/2" NPT
Min./Max. Inlet Pressure	60/150 PSIG (4.1-10.3 bar)
Ambient/Inlet Temp. Range	40°-100° F (4.4°-37.8° C)
Purge Flow @ 100 PSI	3.5 SCFM (5.95 NM³/H)
Pre-coalescer Part #	HN2S-10CW
Replacement element:	10C10-025
Coalescer Part #	HN2S-6CW
Replacement element:	6C10-025
Weight	7.1 lbs. (3.22 kg)

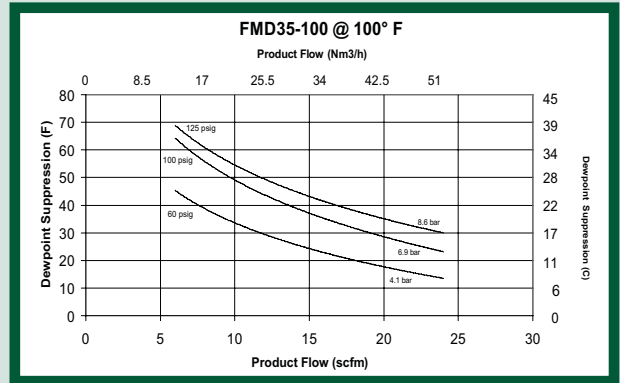

Total Air Consumption = Purge Flow + Product Flow

Part Number FMD35-400

Specifications:

Width	14" (35.56 cm)
Height	38" (96.52 cm)
Port Size	1/2" NPT
Min./Max. Inlet Pressure	60/150 PSIG (4.1-10.3 bar)
Ambient/Inlet Temp. Range	40°-100° F (4.4°-37.8° C)
Purge Flow @ 100 PSI	6 SCFM (4.2 NM³/H)
Pre-coalescer Part #	HN2L-10CW
Replacement element:	10C10-050
Coalescer Part #	HN2L-6CW
Replacement element:	6C10-050
Weight	18.9 lbs. (8.57 kg)

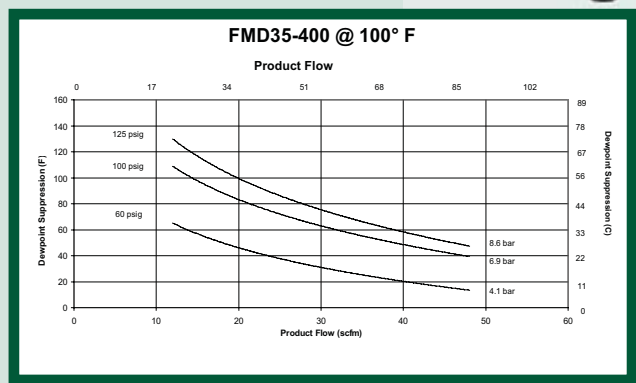

Total Air Consumption = Purge Flow + Product Flow

Part Number FMD40-001

-40° F
Dewpoint
Dryers

Specifications:

Width	5.5" (14.00 cm)
Height	14.5" (36.83 cm)
Port Size	1/4" NPT
Min./Max. Inlet Pressure	60/150 PSIG (4.1-10.3 bar)
Ambient/Inlet Temp. Range	40°-100° F (4.4°-37.8° C)
Purge Flow @ 100 PSI	0.25 SCFM (0.43 NM ³ /H)



Pre-coalescer Part # Q1S-10HM06-013
Replacement element: 10HM06-013

Coalescer Part # Q1S-6HM06-013
Replacement element: 6HM06-013

Weight 0.7 lbs.
(.38 kg)

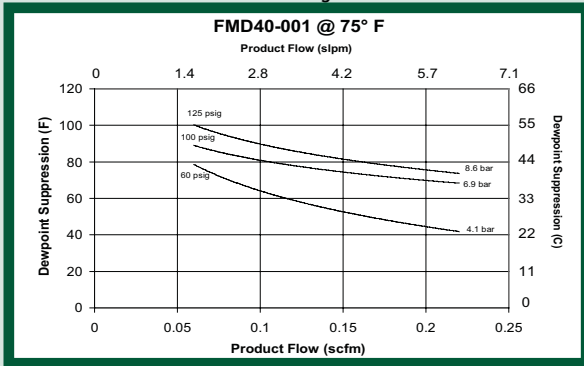

Total Air Consumption = Purge Flow + Product Flow

Part Number FMD40-002

-40° F
Dewpoint
Dryers

Specifications:

Width	6.5" (16.51 cm)
Height	15" (38.10 cm)
Port Size	1/4" NPT
Min./Max. Inlet Pressure	60/150 PSIG (4.1-10.3 bar)
Ambient/Inlet Temp. Range	40°-100° F (4.4°-37.8° C)
Purge Flow @ 100 PSI	0.2 SCFM (0.34 NM ³ /H)



Pre-coalescer Part # Q1S-10HM06-013
Replacement element: 10HM06-013

Coalescer Part # Q1S-6HM06-013
Replacement element: 6HM06-013

Weight 1.9 lbs.
(.86 kg)

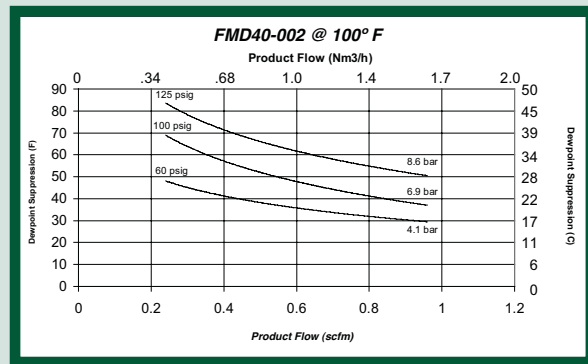

Total Air Consumption = Purge Flow + Product Flow

Part Number FMD40-020

-40° F
Dewpoint
Dryers

Specifications:

Width	10" (25.4 cm)
Height	22" (55.88 cm)
Port Size	1/4" NPT
Min./Max. Inlet Pressure	60/150 PSIG (4.1-10.3 bar)
Ambient/Inlet Temp. Range	40°-100° F (4.4°-37.8° C)
Purge Flow @ 100 PSI	0.5 SCFM (.85 NM ³ /H)



Pre-coalescer Part # HN1S-10C10
Replacement element: 10C10-025

Coalescer Part # HN1S-6C10
Replacement element: 6C10-025

Weight 5.2 lbs.
(2.36 kg)

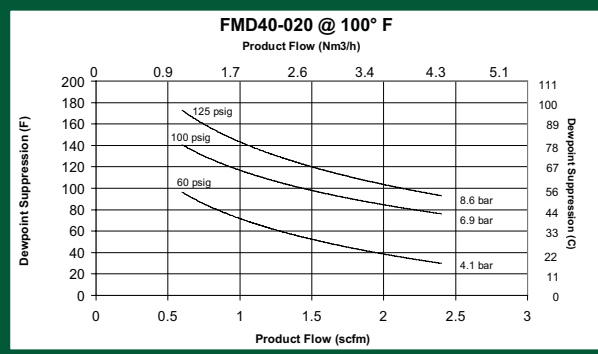

Total Air Consumption = Purge Flow + Product Flow

Part Number FMD40-050

-40° F
Dewpoint
Dryers

Specifications:

Width	14" (35.56 cm)
Height	26" (66.04 cm)
Port Size	1/2" NPT
Min./Max. Inlet Pressure	60/150 PSIG (4.1-10.3 bar)
Ambient/Inlet Temp. Range	40°-100° F (4.4°-37.8° C)
Purge Flow @ 100 PSI	2 SCFM (3.4 NM ³ /H)
Pre-coalescer Part #	HN2S-10CW
Replacement element:	10C10-025
Coalescer Part #	HN2S-6CW
Replacement element:	6C10-025
Weight	13.3 lbs. (3.22 kg)



Part Number FMD40-100

-40° F
Dewpoint
Dryers

Specifications:

Width	14" (35.56 cm)
Height	38" (96.52 cm)
Port Size	1/2" NPT
Min./Max. Inlet Pressure	60/150 PSIG (4.1-10.3 bar)
Ambient/Inlet Temp. Range	40°-100° F (4.4°-37.8° C)
Purge Flow @ 100 PSI	2.5 SCFM (4.25 NM ³ /H)
Pre-coalescer Part #	HN2L-10CW
Replacement element:	10C10-050
Coalescer Part #	HN2L-6CW
Replacement element:	6C10-050
Weight	18.9 lbs. (8.57 kg)

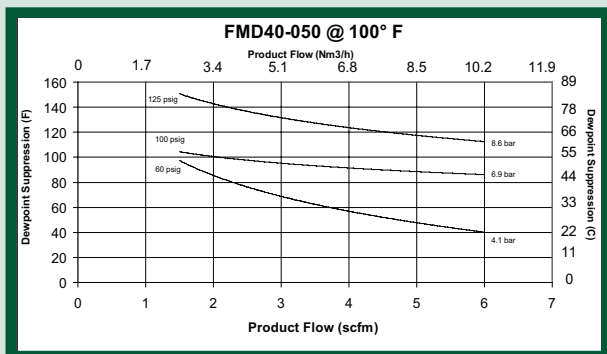
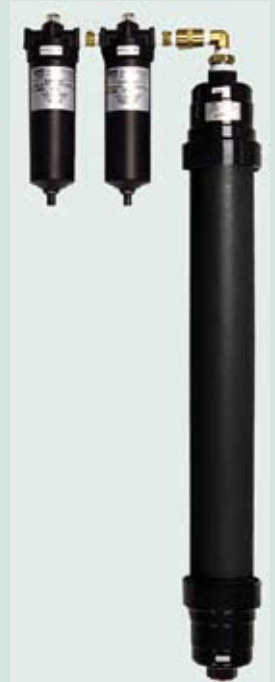

Total Air Consumption = Purge Flow + Product Flow

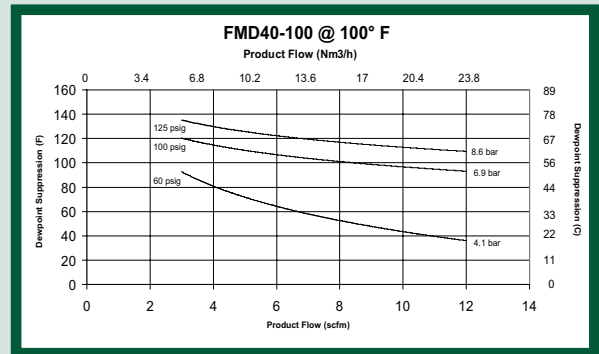

Total Air Consumption = Purge Flow + Product Flow



Compressed Air & Gas Desiccant Dryers

For Point of Use and OEM Applications

Bulletin 1300 - 850/USA



Finite®

FDD DESICCANT DRYER SERIES

- 1/4" to 1" NPT Ports
- Capacities to 60 SCFM
- Pressure Dewpoints Down to -40° F

Finite® Filter's unique in-line air/gas dryer system is engineered for easy desiccant changeouts, longer life and lower pressure drop.

The FDD Series is designed to remove water vapor and aerosols at point-of-use for intermittent flows up to 60 SCFM. Finite dryers do not require steady flow for constant dewpoint suppression.

A color changing moisture indicator with visual sight gauge indicates the need for desiccant replacement.

STANDARD FEATURES

- Zinc Head/Steel Bowl with Integral Sightglass
- Sintered Bronze Elements (prevent desiccant carry over)
- Collar Designed for Easy Changeouts
- Maximum Operating Temperature: 180° F
- Maximum Working Pressure: 300 PSI
- Optimum Working Temperature: Below 100° F



The new FDD Series offers clean dry air for intermittent usage.

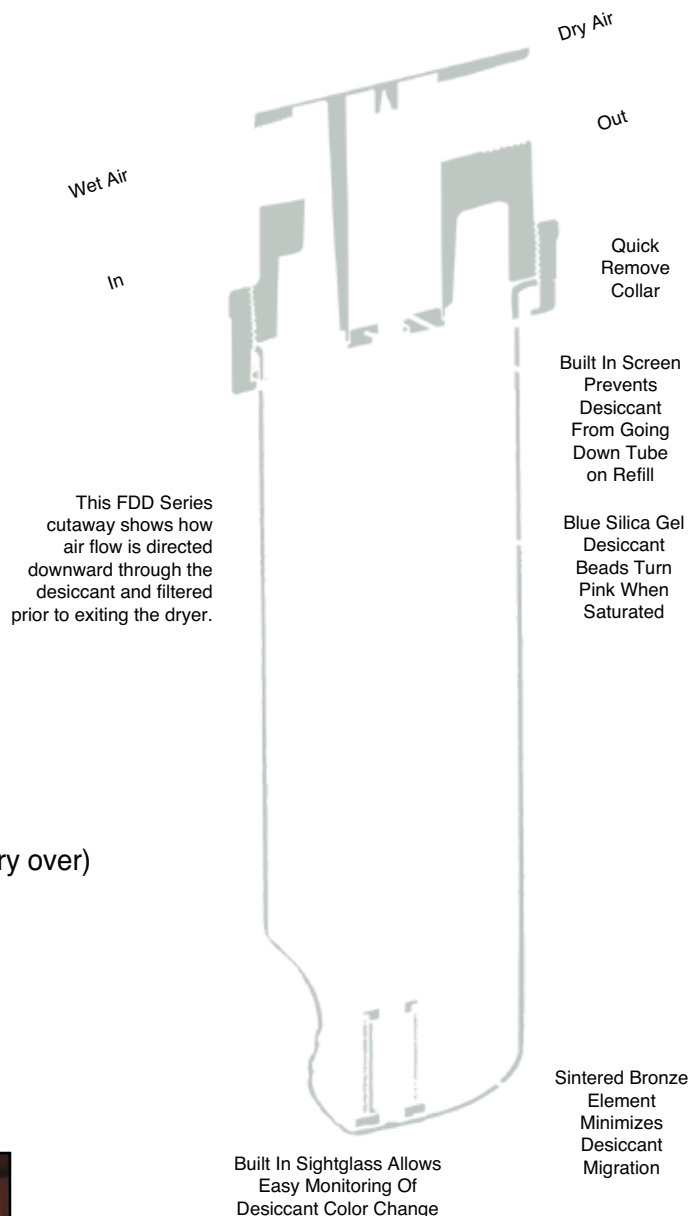

APPLICATIONS

- Intermittent Air Use
- Clean, Dry Air for Pneumatic Applications
- Instrument Protection
- Air Tools Protection Against Gumming and Oxidation
- Auto Body Paint Systems - Helps Prevent Fish Eye Defects
- Valve Actuation - Instrument Air

DESICCANT TYPES

SILICA GEL — Finite Filter's 100 percent indicating silica gel provides Maximum moisture adsorption and dewpoints down to -40° F.

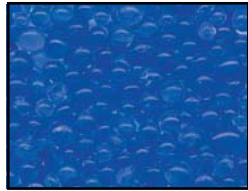

Silica Gel a popular choice for the FDD series.

Outstanding features of Silica Gel include:

- High adsorption capacity - average surface area for each bead is over 200 ft²
- Low abrasion, due to high mechanical strength for long service life
- Ideal packing in bowl due to bead shape
- Uniform color change
- Excellent regeneration characteristics

As the silica beads adsorb moisture, they change from blue to pink, indicating the need for replacement or regeneration. The desiccant can be regenerated by heating in a drying oven to a temperature higher than 212° F but not over 350° F. Desiccant may also be regenerated in microwave ovens.

MOLECULAR SIEVE — Molecular sieves are crystalline, metallic aluminum silicates. The type 4A offers exceptional water vapor adsorption characteristics. Dewpoints are attainable to -40° F.

RECOMMENDED INSTALLATION

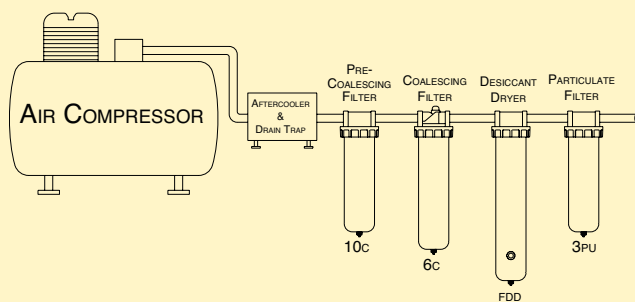

- Always place a moisture separator and/or pre-coalescing filter upstream to remove bulk liquids
- Always place a coalescing filter upstream to remove oil. Desiccant coated with oil will not adsorb moisture
- A 3 micron (or better) particulate filter is recommended downstream to remove desiccant dust in critical applications

WHY Finite[®] DESICCANT DRYERS?

Finite[®] desiccant dryers are the simplest and most reliable method of ensuring your sensitive pneumatic equipment is not exposed to damaging moisture. When air is compressed, the temperature of air is increased as is its capacity to hold moisture. As the hot moist air travels downstream through the pipelines, it cools, allowing the moisture to condense. Aftercoolers, filters, drain traps and drip legs are effective for removing condensate. For removing residual water vapor and aerosols, use the Finite desiccant dryer.



FDD15

- 1/4" - 3/4" NPT
- Flows to 15 SCFM
- Low Flow Intermittent Use



FDD30

- 3/8" - 1" NPT
- Flows to 30 SCFM
- Medium Flow for Intermittent Use or Longer Time Between Desiccant Changeouts



FDD60

- 1/2" - 1" NPT
- Flows to 60 SCFM
- For Intermittent Use or Longer Time Between Desiccant Changeouts

How Do THEY WORK?

As the wet compressed air flows through the inlet port and down through the bed of desiccant, the desiccant beads adsorb the water vapor and aerosols. The silica gel beads are so effective in adsorption, the air humidity can be reduced to a -40° F pressure dew point. Unless your compressed air is exposed to a temperature below the dewpoint, there will be no further condensation forming in your air lines.

After the moisture has been removed, the dry air passes through a sintered bronze element, up the center tube, and exits through the outlet port. As long as the desiccant is replaced regularly, your equipment will receive ultra dry, moisture-free air.



This sight gauge shows the color of the silica gel. When the gel turns from blue to pink, it is time to change the desiccant.

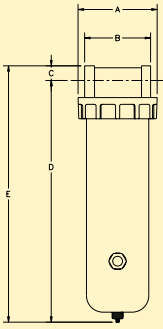

DIMENSIONS

	A*	B*	C	D	E	Weight
FDD15	4 15/16	4 1/16	13/16	12 11/16	13 1/2	8 lbs.
FDD30	4 15/16	4 1/16	13/16	22 7/16	23 1/4	13 lbs.
FDD60	4 15/16	4 1/16	13/16	29 7/16	30 1/4	20 lbs.

*Dimensions A & B do not include reducer bushings
 Note: Weight is for housing only. Bowl removal requires a minimum of 2".

ORDERING INFORMATION

MODEL No. HOUSING ONLY**	PIPE SIZE (NPT)	FLOW CAPACITY	BOWL CAPACITY DESICCANT (LBS)
FDD15-02*	1/4"	15 SCFM	2 1/2
FDD15-03*	3/8"	15 SCFM	2 1/2
FDD15-04*	1/2"	15 SCFM	2 1/2
FDD15-06	3/4"	15 SCFM	2 1/2
FDD30-03*	3/8"	30 SCFM	5
FDD30-04*	1/2"	30 SCFM	5
FDD30-06	3/4"	30 SCFM	5
FDD30-08	1"	30 SCFM	5
FDD60-04*	1/2"	60 SCFM	10
FDD60-06	3/4"	60 SCFM	10
FDD60-08	1"	60 SCFM	10

*These dryers supplied with reducer bushings.
 **Desiccant sold separately.

PERFORMANCE

The flow capacities in the table are nominal ratings provided for reference. These capacities are recommended for minimal pressure drop and average desiccant life. A supply of low flow/low humidity air will provide longer desiccant life, whereas high flow/high humidity air will require more frequent desiccant changes.

Installed in an application with intermittent flow, Finite desiccant dryers will typically dry air for weeks before the silica gel desiccant requires replacement or regeneration.

DESICCANT TYPE	5 LB CAN	MASTER PACK 4x5 LB CAN
Silica Gel (all indicating)	FSGM100-1	FSGM100-4
Molecular Sieve (non-indicating)	FMS100-1	FMS100-4

For detailed performance curves, please contact **Finite® Filter**.

SPARE PARTS

MODEL NUMBER	REPAIR KIT	ELEMENTS
FDD15	FRKDD15-02-06	F504Z77-90
FDD30	FRKDD30-03-08	F504Z77-90
FDD60	FRKDD60-03-08	EK602B-BR

Note: A repair kit consists of a filter element, filter retainer, o-ring, stud, bottom nut, PVC tube and a strainer.

DID YOU KNOW ?

When a grade 6 microglass coalescer is installed ahead of an FDD Dryer, 99.97% of all contaminants are removed and desiccant life is greatly enhanced.



High Pressure Filters

Compressed Air & Gas

- CNG and Alternative Fuel Filters
- Pressures to 6000 PSIG
- Ductile Iron, Stainless Steel & Aluminum Housings

Bulletin 1300 - 997/USA



High Pressure
& CNG Filters

Finite®

“High pressure systems are plagued with problems of contamination and require filtration protection.”

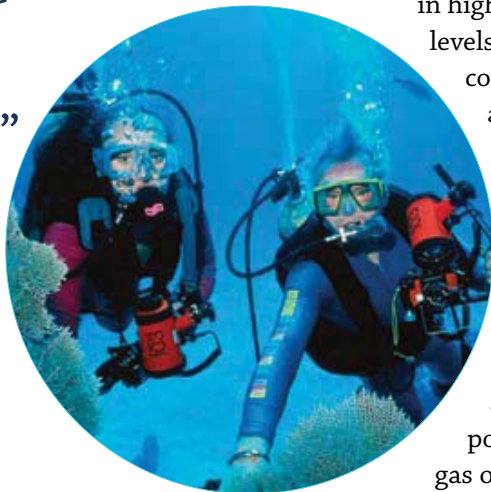
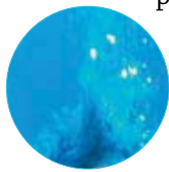

High pressure compressors are used in a variety of applications. Many owners, operators and designers of high pressure compressed air or gas systems rely on Finite for high-quality air treatment filters. End users of high pressure compressed air, such as scuba divers and fire rescue workers, depend on this high quality breathable air.

Throughout the stages of compression many contaminants can enter into the system. Excessive amounts of liquid aerosols and solid particulate contamination are common in high pressure systems. In addition, higher temperature levels are possible and may cause liquid oils to varnish. This contamination can lead to poor component performance and wear that may lead to unscheduled maintenance.

Even submicronic contaminants in compressed air or gas systems can foul multistage compressors, increase maintenance costs or eventually make it into your final product.

Finite offers a variety of high pressure compressed air and gas filters. With our wide range of elements, we have a solution for every stage of compression, as well as at the point of use. Whether you are storing high pressure air or gas or using a continuous flow, count on Finite to protect your equipment from contamination. Finite is the solution to ending high pressure contamination fouling.



Alternative Vehicles Need High Pressure Filtration

Compressed Natural Gas, or CNG, is a leading alternative to traditional fuel for the automotive industry. CNG is used in passenger vehicles, pickup trucks, in transit and on school buses. It can be less expensive than gasoline, and is more environmentally friendly – it reduces the amount of carbon monoxide, carbon dioxide and hydrocarbon vehicle Exhaust emissions. Natural gas is gathered from a pipeline and

travels to a connecting compressor station. The gas is elevated to pressures ranging from 2000 PSIG up to 5000 PSIG and the resultant CNG is stored in large tanks. The CNG then makes its way to a gas dispenser where it is ready for use in natural gas vehicles. Contaminants can enter into the gas at any stage of this processing. Filters are critical at each stage to ensure clean gas as a final product. Contamination that collects

during handling, water that condenses in tanks and compressors that leak oil into the fuel stream are all problems that could shorten the life of expensive equipment, create unnecessary downtime and increase maintenance costs. From pipeline to engine, Finite filters provide the critical filtration required for most alternative fuel systems. See page 67 for more detailed information on this application.

How to select your Finite Filter...

<p>The following steps will help you to choose the correct filter for your application. If there are other factors involved or if you have special requirements, call one of Finite's application engineers.</p>	<p>Evaluate the requirements of your application. The sketches on pages 66-67 depict popular Examples of breathing air, PET bottle blowing and alternative fuel applications.</p>	<p>What type of filtration is needed? Coalescing filter media removes solid and liquid contaminants from gas streams. Particulate filter media removes solids from gas streams. Adsorber media removes hydrocarbon vapors from gas streams. See pages 68-69 for more detailed information.</p>
<p>Are you searching for a specific micron rating... or efficiency rating? If so, pages 69 provide a complete breakdown of Finite's filter media grades and their performance specifications.</p>	<p>What are the operating conditions of your application? Key criteria to consider: flow, pressure, temperature, materials of construction (stainless steel, nylon, aluminum, etc.). Pages 70-89 provide detailed descriptions of the various products available.</p>	<p>Sizing: Flow charts are provided for each high pressure filter series. Flows are listed at various operating pressures. Filters are available with flows up to 6500 SCFM and pressure ratings up to 6000 PSIG.</p>



High Pressure & CNG Filters

Applications

High Pressure Breathing Air

The filtration of compressed air is critical to ensure that it meets stringent air quality requirements for use in breathing air applications as set forth by North American agencies such as the Occupational Health and Safety Administration (OSHA) and Canadian Standards Association (CSA). Breathing air is used for scuba tanks, fire rescue

equipment, and emergency respiratory gear. Any contaminants in the air stream may cause equipment damage and malfunction, requiring costly repairs and replacements, and ultimately creating a hazardous situation for any users of high pressure breathing air apparatus. The use of filters will protect the consumer's health and keep equipment safe and

fully operational. At the source, a coalescing filter will remove any oil or other liquid contaminants that may be carried downstream. At the point of use, conventional compressed air must be free of impurities such as moisture, oil vapors and any harmful tastes and/or odors before it can safely be used as breathing air.

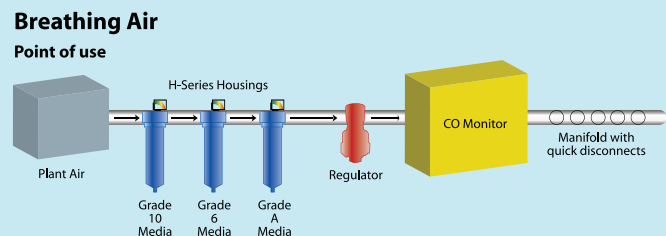
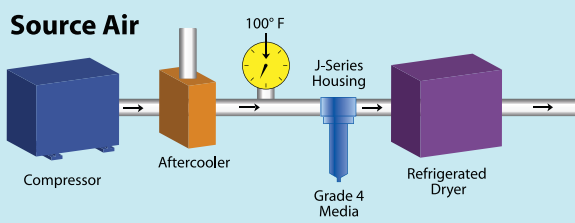

For more information on H-Series filters, please see Bulletin 1300-993C.

High Pressure & CNG Filters



PET Blow Molding

PET, or polyethylene terephthalate, is a recyclable material used to make bottles by blow molding. Food and beverage containers are just a few of the many products that can be manufactured from this thermoplastic. In order to ensure that these products remain contaminant free throughout a process, they must be manufactured with clean, dry air. The proper combination of filters will prevent compressor oils, pipe scale and other damaging impurities from building up on equipment.

PET Blow Molding

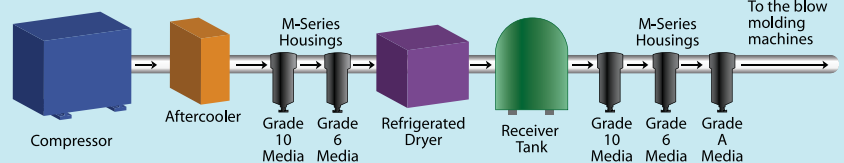

At the CNG Fueling Station

Installing a lower pressure particulate filter (H-Series Housing 3PU Media) before the compressor station will remove pipe scale to prevent compressor damage. Before the gas is transported from storage to the dispenser, prefiltration of the gas with two-stage coalescing will eliminate solids, oil and water generated during underground transit. For extra protection, a high efficiency coalescer should be placed at the gas dispenser to protect sensitive dispenser metering equipment and prevent oil from making its way into the vehicle.

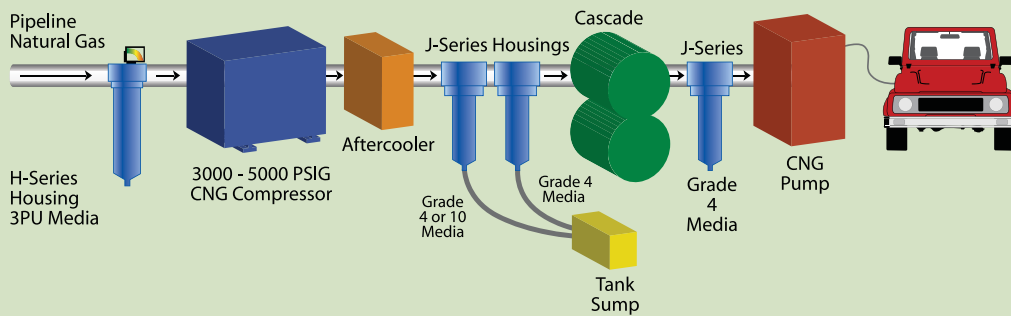

For more information on H-Series filters, please see Bulletin 1300-993C.



Other applications include:

- General high pressure compressed air
- High pressure testing
- Offshore applications
- High pressure gas storage
- Corrosive gases
- Specialty gases
- Air-blast circuit breakers
- Leak testing of hydraulic equipment
- Shipboard air distribution systems

Onboard CNG Vehicles

Filtration is the key to guarding against damaging contaminants that could ruin a fuel system. Installing a coalescer upstream of the high pressure regulator extends the system's life and reduces maintenance costs. A low pressure filter can also be used downstream of the regulator to protect other fuel injection system components.

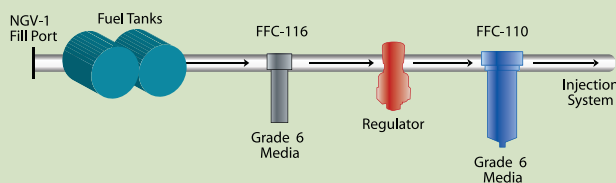

Finite Media Types, Grades and Efficiencies

Coalescing elements:

Coalescing elements are specially designed for the removal of liquid contaminants from gaseous flows. These media types flow from the inside of the element to the outside. Coalesced liquid (water and oil) collects in the bowl where it is drained, while clean air or gas exits the housing through the outlet port. Particulate contaminants are captured and held in the media.

Water Separator element:

Particulate elements:



Type C

Coalescing element composed of an epoxy saturated, borosilicate glass microfiber tube in intimate interlocking contact with a rigid retainer. Surrounded by a coarse fiber drain layer, retained by a synthetic fabric safety layer. Some models are available with molded elastomeric end seals (CU), or with metal end caps and fluorocarbon gaskets.

For use with:

- FFC-110 (500 PSIG) Page 70
- FFC-110L (500 PSIG) Page 70
- SN8S (500 PSIG) Page 71
- M-Series (800 PSIG) Pages 72-74
- A5R/A1R (1000 PSIG) Page 75
- SM-Series (1200 PSIG) Page 76-77
- FFC-112 (3600 PSIG) Page 78
- FFC-112 SAE (3600 PSIG) Page 78
- FFC-113 (3600 PSIG) Page 79
- J-Series (5000 PSIG) Pages 80-82
- S5R/S1R (5000 PSIG) Page 83
- FFC-116 (5000 PSIG) Page 85
- SJ-Series (6000 PSIG) Pages 86-87



Type H

Coalescing element similar to type "C," however no rigid retainer is used. Typically used in applications with low or constant flow rates.

For use with:

- A5R/A1R (1000 PSIG) Page 75
- SM-Series (1200 PSIG) Pages 76-77
- S5R/S1R (5000 PSIG) Pages 83



Type Q

Coalescing element with the same configuration as "C" tube, but with "3P" type pleated cellulose prefilter built-in. Includes molded elastomeric end seals (QU). Some models offer the option of metal end caps and fluorocarbon gaskets.

For use with:

- M-Series (800 PSIG) Pages 72-74
- SM-Series (1200 PSIG) Pages 76-77



Type 7CVP

Coalescing element made of pleated glass media. Metal retained for added strength. Includes metal end caps and fluorocarbon gaskets for proper sealing. Only available in grade 7.

For use with:

- SN8S (500 PSIG) Page 71
- M-Series (800 PSIG) Pages 72-74



Type 100WS

This all stainless steel element has two metal retainers with rolled mesh screen in between. This cleanable element combines liquid droplets and aerosols, separating the liquids from the gas stream in systems with high liquid loads.

For use with:

- SN8S (500 PSIG) Page 71
- M-Series (800 PSIG) Pages 72-74
- J-Series (5000 PSIG) Pages 80-82
- SJ-Series (6000 PSIG) Pages 86-87



Type 3P

Pleated cellulose particulate removal element. Includes molded elastomeric end seals (3PU). Some models offer the option of metal end caps and fluorocarbon gaskets.

For use with:

- SN8S (500 PSIG) Page 71
- M-Series (800 PSIG) Pages 72-74
- SM-Series (1200 PSIG) Pages 76-77
- J-Series (5000 PSIG) Pages 80-82
- SJ-Series (6000 PSIG) Pages 86-87

High Pressure & CNG Filters

Grade 4

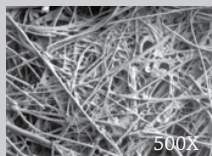

Grade 4 filter elements are very high efficiency coalescers; for elevated pressures or lighter weight gases. Recommended when system pressure exceeds 500 PSIG.

Grade 6

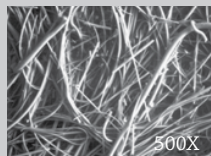

Grade 6 filter elements are used when "total removal of liquid aerosols and suspended fines" is required. **Because of its overall performance characteristics, this grade is most often recommended below 500 PSIG.**

Grade 7CVP

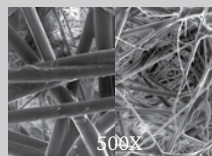

Grade 7CVP filter elements are made with two layers. The inner layer (left) effectively traps dirt particles, protecting and extending the life of the outer layer. The coalescing outer layer (right) consists of a dense matrix of glass fibers, providing highly efficient aerosol removal.

Grade 8

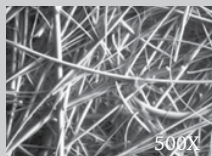

Grade 8 filter elements provide high efficiency filtration in combination with high flow rate and long element life.

Grade 10

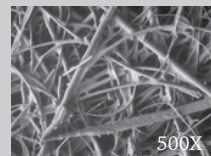

Grade 10 filters are used as prefilters for grade 6 to remove gross amounts of aerosols or tenacious aerosols which are difficult to drain. This grade is often used as a 'coarse' coalescer.

Media Grades:

Adsorption elements:

Particulate filters such as G, F, T and 3P flow from the outside of the element to the inside. Particles collect in the element, while the clean air exits through the outlet port.

Adsorption elements are used to remove vapors (hydrocarbon or water) that are not removed by the coalescing filter. Hydrocarbon vapors collect in the element, while clean air exits the housing through the outlet port. In this element, the air or gas flows from the outside of the element to the inside.



Type G

Particulate removal element constructed of the same fiber matrix as type "C", but with no rigid retainer or drain layer.

For use with:

- A5R/A1R (1000 PSIG) Page 75
- SM-Series (1200 PSIG) Pages 76-77
- S5R/S1R (5000 PSIG) Page 83
- S11L (5000 PSIG) Page 84



Type F

Particulate removal element like "G" tube, except fluorocarbon saturant replaces epoxy.

For use with:

- A5R/A1R (1000 PSIG) Page 75
- SM-Series (1200 PSIG) Pages 76-77
- S5R/S1R (5000 PSIG) Page 83
- S11L (5000 PSIG) Page 84



Type T

Particulate removal element like "G" tube, except high temperature fluorocarbon saturant replaces epoxy.

For use with:

- A5R/A1R (1000 PSIG) Page 75
- SM-Series (1200 PSIG) Pages 76-77
- S5R/S1R (5000 PSIG) Page 83
- S11L (5000 PSIG) Page 84



Type A

Hydrocarbon vapor removal element. Ultrafine grained, highly concentrated, activated carbon sheet media. Includes molded elastomeric end seals (AU). Some models offer the option of metal end caps and fluorocarbon gaskets.

For use with:

- SN8S (500 PSIG) Page 71
- M-Series (800 PSIG) Pages 72-74
- SM-Series (1200 PSIG) Pages 76-77
- J-Series (5000 PSIG) Pages 80-82
- SJ-Series (6000 PSIG) Pages 86-87



Type 10JWM

Vapor adsorbing filter element consisting of a grade 10 microfiber tube, strengthened by a perforated metal retainer and then filled with molecular sieve, which works as a desiccant dryer, making the air clean and dry as it exits. This element should always be preceded by a coalescing filter.

For use with:

- J-Series (5000 PSIG) Pages 80-82



Type 10JWA

Vapor adsorbing filter element consisting of a grade 10 microfiber tube, strengthened by a perforated metal retainer and then filled with activated alumina, which works as a desiccant dryer, making the air clean and dry as it exits. This element should always be preceded by a coalescing filter.

For use with:

- J-Series (5000 PSIG) Pages 80-82

Finite[®] media grades and specifications

Finite media grades determine the filtration efficiency. Capture efficiencies are available up to 99.999%. Micron ratings range from 0.01 to 3 micron. The columns on the right note both the wet and dry pressure drops.

Media Grade	Coalescing Efficiency 0.3 to 0.6 Micron Particles	Coalescing Filters - C, H, Q, 7CVP Maximum Oil Carryover ¹ PPM w/w	Particulate Filters - 3P, G, F, T Micron Rating	Pressure Drop (PSID) @ Rate Flow ²	
				Media Dry	Media Wet With 10-20 wt. oil
4	99.995%	0.003	0.01	1.25	3-4
6	99.97%	0.008	0.01	1.0	2-3
7CVP	99.5%	0.09	0.5	0.25	0.5-0.7
8	98.5%	0.2	0.5	0.5	1-1.5
10	95%	0.85	1.0	0.5	0.5
100WS	N/A	N/A	100 Nominal	<0.25	0.25
3P	N/A	N/A	3.0	0.25	N/A
A	99% ³	N/A	3 Nominal	1.0	N/A

¹Tested per ADF-400 at 40 ppm inlet.

²Add dry + wet for total pressure drop.

³Oil vapor removal efficiency is given for A media

Grade 3P

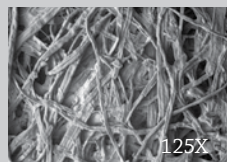

Three micron pleated cellulose filters are used for particulate interception where very high dirt holding capacity and a relatively fine pore structure are required.

Grade A

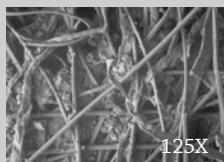

A (Adsorption) filters are used to remove hydrocarbon vapor, most typically in preparation for breathing air. (Must be preceded by grade 6C coalescer.)

500 PSIG Pressure Filters

FFC-110



Many CNG powered commuter vehicles, such as shuttle buses, taxis or vans, rely on FFC-110 filters to protect contaminants in the fuel tank from entering the engine.

Finite's FFC-110 is often used onboard CNG (compressed natural gas) powered vehicles to prevent contaminants in the fuel tank from getting into the engine, protecting critical engine components, like fuel injectors. Its small size allows for versatile installation and easy servicing. Each housing is powder painted for long-term corrosion protection. These coalescers are ideal for operating environments up to 500 PSIG. Coalescing efficiencies of 95% (grade 10) or 99.97% (grade 6) can be chosen to match the filter to the application. Both the FFC-110 and FFC-110L have an 1/8" NPT drain port with a brass petcock manual drain.

Specifications:

Model Number	Port Size (NPT)	Max. Pressure	Max. Temp.	Materials of Construction			Seals	Sump Capacity	Weight	Dimensions	
				Head	Internals	Bowl				Length	Width
FFC-110	1/4"	500 PSIG (34 bar)	175°F (79°C)	Chromated Aluminum	Stainless Steel	Chromated Aluminum	Buna-N	5.1 oz. (150 ml)	1.5 lbs. (0.68 kgs.)	7.8" (198.1mm)	3.1" (78.7mm)
FFC-110L	1/2"	500 PSIG (34 bar)	175°F (79°C)	Chromated Aluminum	Stainless Steel	Chromated Aluminum	Buna-N	4.7 oz. (140 ml)	1.8 lbs. (0.82 kgs.)	10.2" (259.1mm)	3.1" (78.7mm)

Flow Rates (SCFM):

Filter Housing Model	Media Grade	100 PSIG	250 PSIG	500 PSIG
FFC-110	6	15	35	67
	10	25	58	112
FFC-110L	6	30	69	135
	10	50	115	224

How to Order:

							Bowl	Element Grade	Example:	
F	F	C	-	1	1	0	Leave blank for standard	-	6	FFC-110-6
							L (Long)		10	

Mounting bracket available: BK-M

Replacement Elements Available:

Filter Housing Model	Media Grade 6	Media Grade 10
FFC-110	CLS110-6 X 8	CLS110-10 X 8
FFC-110L	CLS110-6L X 4	CLS110-10L X 4

Note: X 4 or X 8 in the part number signifies how many elements are sold in a Box.



SN8S

Bottling plants use stainless steel system components for their critical processes. In applications where stainless steel is required, use the SN8S to remove contaminants from your compressed air or gas system.

Finite's 500 PSIG SN8S filter is the best solution for most critical or corrosive compressed air/gas applications. Its 2" NPT stainless steel housing is a perfect fit for food processing, bottling plants and pharmaceutical manufacturing, where stainless steel system components are required. Bulk liquid from gas separation, oil coalescing, particulate removal and vapor adsorber filter elements are available. The housing has a plugged 1/4" NPT drain connection. The optional ADS-50 (see page 89) stainless steel auto drain can be easily connected with standard pipe fittings.

Specifications:

Model Number	Port Size (NPT)	Max. Pressure	Max. Temp. for each Element Type	Materials of Construction			Seals	Sump Capacity	Weight	Dimensions	
				Head	Internals	Bowl				Length	Width
SN8S	2"	500 PSIG (34 bar)	175°F (CU, 3PU, AU) 225°F (7CVP) 350°F (100WS) 450°F (DS)	316 Stainless Steel	316 Stainless Steel	316 Stainless Steel	Fluoro-carbon	14.6 oz (431.8 ml)	32.0 lbs. (14.5 kgs.)	27.7" (703.6mm)	6.3" (160.0mm)

Flow Rates (SCFM):

Filter Housing Model	Media Grade	100 PSIG	250 PSIG	500 PSIG
SN8S	4CU/4DS	340	785	1526
	6CU/6DS	450	1038	2019
	8CU/8DS	600	1385	2692
	10CU/10DS	750	1731	3366
	3PU	750	1731	3366
	AU	450	1038	2019
	7CVP	750	1731	3366
	100WS	750	1731	3366

How to Order:

S	N	8	S	X	1
---	---	---	---	---	---

Example: SN8S X 1

How to Order Replacement Elements:

Element and housing sold separately.
Elements available (one per Box):

- *CU24-187 X 1
- *DS24-187 X 1
- 3PU24-187 X 1
- AU24-187 X 1
- 7CVP24-187 X 1
- 100WS24-187 X 1

* insert grade: 4, 6, 8, 10

For more information on element selection, please see pages 68-69.

For Example: 6CU24-187 X 1

800 PSIG Pressure Filters

M-Series

PET bottle blowing plants rely on the filtration protection of the M-Series to meet stringent standards for contact with food and beverage containers.



Finite's M-Series provides the needed filtration for a wide variety of compressed air/gas applications. Varied porting and connection styles, along with a robust design make this an extremely versatile filter. It is a perfect fit for interstage filtration applications for multistage, high pressure gas compressors. The aluminum heads and drawn aluminum bowls are compatible with special gases such as argon, hydrogen, compressed natural gas and helium. This housing design minimizes the problem of porosity often present with housings made by die casting.



Specifications:

Model Number	Port Size NPT	Max. Pressure	Max. Temp.	Materials of Construction				Sump Capacity	Weight	Dimensions	
				Head	Internals	Bowl	Seals			Length	Width
MN1S	1/4"	800 PSIG (55 bar)	175°F (79°C)	Machined Aluminum	Stainless Steel/Plastic	Aluminum	Buna-N	5.1 oz. (150 ml)	1.83 lbs. (0.83 kgs.)	7.89" (200 mm)	3.06" (78 mm)
MN1L	1/4"	800 PSIG (55 bar)	175°F (79°C)	Machined Aluminum	Stainless Steel/Plastic	Aluminum	Buna-N	4.7 oz. (140 ml)	2.19 lbs. (0.99 kgs.)	10.28" (261 mm)	3.06" (78 mm)
MN15S	3/8"	800 PSIG (55 bar)	175°F (79°C)	Machined Aluminum	Stainless Steel/Plastic	Aluminum	Buna-N	5.1 oz. (150 ml)	1.82 lbs. (0.82 kgs.)	7.89" (200 mm)	3.06" (78 mm)
MN15L	3/8"	800 PSIG (55 bar)	175°F (79°C)	Machined Aluminum	Stainless Steel/Plastic	Aluminum	Buna-N	4.7 oz. (140 ml)	2.17 lbs. (0.98 kgs.)	10.28" (261 mm)	3.06" (78 mm)
MN2S	1/2"	800 PSIG (55 bar)	175°F (79°C)	Machined Aluminum	Stainless Steel/Plastic	Aluminum	Buna-N	5.1 oz. (150 ml)	1.80 lbs. (0.82 kgs.)	7.89" (200 mm)	3.06" (78 mm)
MN2L	1/2"	800 PSIG (55 bar)	175°F (79°C)	Machined Aluminum	Stainless Steel/Plastic	Aluminum	Buna-N	4.7 oz. (140 ml)	2.15 lbs. (0.98 kgs.)	10.28" (261 mm)	3.06" (78 mm)
MN3S	3/4"	800 PSIG (55 bar)	175°F (79°C)	Machined Aluminum	Stainless Steel/Plastic	Aluminum	Buna-N	9.1 oz. (270 ml)	5.01 lbs. (2.27 kgs.)	10.83" (275 mm)	4.55" (116 mm)
MN4S	1"	800 PSIG (55 bar)	175°F (79°C)	Machined Aluminum	Stainless Steel/Plastic	Aluminum	Buna-N	9.1 oz. (270 ml)	4.90 lbs. (2.22 kgs.)	10.83" (275 mm)	4.55" (116 mm)
MN4L	1"	800 PSIG (55 bar)	175°F (79°C)	Machined Aluminum	Stainless Steel/Plastic	Aluminum	Buna-N	9.1 oz. (270 ml)	5.54 lbs. (2.51 kgs.)	14.36" (365 mm)	4.55" (116 mm)
MN8S	2"	800 PSIG (55 bar)	175°F (79°C)	Sand Cast Aluminum	Aluminum	Aluminum	Buna-N	14.9 oz. (440 ml)	10.37 lbs. (4.71 kgs.)	18.60" (472 mm)	5.91" (150 mm)

How to Order:

Series Name	Port Type	Port Size	Bowl	Element Grade	Element Type	End Seal	Accessories
M	N (NPT) T (BSPT) F (BSPF)	1 (1/4") 15 (3/8") 2 (1/2") 3 (3/4") 4 (1") 8 (2")	S (Standard) L (Long) Note: L is not available for 3/4" and 2" port size housings	4	C (Coalescer)	1/4" - 1" port size: Leave blank for no end seal or U (Urethane) 2" port size: V (Fluorocarbon)	N (No Accessories) G (Gauge) Standard on 2" port
				6			
				8			
				10	Q (Coalescer with built-in prefilter)	U (Urethane) Standard on all sizes	
				4			
				6			
8							
10	100WS	1/4" - 1" port size: U (Urethane) For 2" leave blank (standard fluorocarbon end seals)					
Leave blank							
Leave blank	7CVP (only available on 2" port)	Leave blank (standard fluorocarbon end seals)					
Leave blank	3P (Pleated Cellulose) Particulate element	1/4" - 1" port size: U (Urethane) 2" port size: V (Fluorocarbon)					
Leave blank							
Leave Blank	A (Adsorber)	1/4" - 1" port size: U (Urethane) 2" port size: V (Fluorocarbon)					



This G option is a great way to monitor pressure drop and determine when to replace the filter element.

Examples: MN2S-6QUG
MN3L-3PUN
MN8S-6CVG
MN8S-7CVPG

High Pressure & CNG Filters

How to Order Replacement Elements:

Housings are sold with one element. Build your own replacement element with the chart below:

Housing	Element Grade and Type	Element Size
M_1S M_15S M_2S	*C,*CU,*QU, 3PU, AU, 100WSU	10-025
M_1L M_15L M_2L	*C,*CU,*QU, 3PU, AU, 100WSU	10-050 (for 100WSU use 10-025)
M_3S M_4S	*C,*CU,*QU, 3PU, AU, 100WSU	15-060
M_4L	*C,*CU,*QU, 3PU, AU, 100WSU	15-095 (for 100WSU use 15-060)
M_8S	*CV,*QU, 3PV, AV, 100WS, 7CVP	25-130

Note: _insert port type. See How to Order above for more information.

1. Determine the housing you have by choosing from the "Housing" column on the chart.
2. Determine the element type and grade you need. *Insert grades 4,6,8 or 10 for C, CU, CV or QU. See pages 68-69 for more detail on grade selection.
3. Determine the corresponding element size by choosing from the "Element Size" column on the chart.
4. Combine "Element Grade and Type" designation with "Element Size" to get element part number.

Ex: 3PU10-025 or 6CU10-025

Element Box quantity depends on media type selected.

Mounting brackets available MB-2 (1/4" - 1/2" port size)
BK-3 (3/4" - 1" port size)

For M-Series Flow Rates... see next page!



M-Series (800 PSIG) Flow Rates (SCFM):

Filter Housing	Media Grade	100 PSIG	250 PSIG	500 PSIG	800 PSIG
M_1S	4C/4Q	11	25	49	78
	6C/6Q	15	35	67	107
	7CVP	NA	NA	NA	NA
	8C/8Q	20	46	90	142
	10C/10Q	25	58	112	178
	3P	25	58	112	178
	100WS	50	115	224	355
	A	15	35	67	107
M_1L	4C/4Q	23	53	103	163
	6C/6Q	30	69	135	213
	7CVP	NA	NA	NA	NA
	8C/8Q	41	95	184	291
	10C/10Q	50	115	224	355
	3P	50	115	224	355
	100WS	50	115	224	355
	A	30	69	135	213
M_15S	4C/4Q	15	35	67	107
	6C/6Q	20	46	90	142
	7CVP	NA	NA	NA	NA
	8C/8Q	27	62	121	192
	10C/10Q	33	76	148	235
	3P	33	76	148	235
	100WS	66	152	296	469
	A	20	46	90	142
M_15L	4C/4Q	30	69	135	213
	6C/6Q	40	92	179	285
	7CVP	NA	NA	NA	NA
	8C/8Q	55	127	247	391
	10C/10Q	66	152	296	469
	3P	66	152	296	469
	100WS	66	152	296	469
	A	40	92	179	285
M_2S	4C/4Q	19	44	85	135
	6C/6Q	25	57	112	178
	7CVP	NA	NA	NA	NA
	8C/8Q	34	78	153	242
	10C/10Q	42	97	189	299
	3P	42	97	189	299
	100WS	83	192	372	590
	A	25	58	112	178

Filter Housing	Media Grade	100 PSIG	250 PSIG	500 PSIG	800 PSIG
M_2L	4C/4Q	38	88	171	270
	6C/6Q	50	115	224	355
	7CVP	NA	NA	NA	NA
	8C/8Q	68	157	305	483
	10C/10Q	83	192	372	590
	3P	83	192	372	590
	100WS	83	192	372	590
	A	50	115	224	355
M_3S	4C/4Q	61	141	274	434
	6C/6Q	80	185	359	569
	7CVP	NA	NA	NA	NA
	8C/8Q	109	252	489	775
	10C/10Q	133	307	597	946
	3P	133	307	597	946
	100WS	133	307	597	946
	A	80	184	359	569
M_4S	4C/4Q	76	175	341	541
	6C/6Q	100	231	449	711
	7CVP	NA	NA	NA	NA
	8C/8Q	136	314	610	967
	10C/10Q	166	383	745	1181
	3P	166	383	745	1181
	100WS	232	535	1041	1650
	A	100	231	449	711
M_4L	4C/4Q	106	245	476	754
	6C/6Q	140	323	628	995
	7CVP	NA	NA	NA	NA
	8C/8Q	191	441	857	1358
	10C/10Q	232	535	1041	1650
	3P	232	535	1041	1650
	100WS	232	535	1041	1650
	A	140	323	628	995
M_8S	4C/4Q	260	600	1167	1849
	6C/6Q	350	808	1571	2489
	7CVP	600	1385	2692	4267
	8C/8Q	465	1073	2087	3307
	10C/10Q	600	1385	2692	4267
	3P	600	1385	2692	4267
	100WS	600	1385	2692	4267
	A	350	808	1571	2489

Note: _insert port type. See How to Order on page 73 for more information.

1000 PSIG Pressure Filters

A*R

This robust but lightweight aluminum housing is designed especially for bypass gas sampling of specialty gases.



This lightweight, 1000 PSIG filter is constructed of aluminum and offers your choice of high efficiency particulate and coalescing filter elements. This product can be used for CNG or specialty gas applications. The A*R includes a drain port with a plug. The connection size of the drain port matches the inlet and outlet connection size, making it ideal for bypass gas sampling.

*specify part number A5R for 1/8" NPT connections or A1R for 1/4" NPT connections.

Specifications:

Model Number	Port Size (NPT)	Max. Pressure	Max. Temp.	Materials of Construction			Seals	Sump Capacity	Weight	Dimensions	
				Head	Internals	Bowl				Length	Width
A5R, A1R	1/8", 1/4"	1000 PSIG (68 bar)	225°F All Media Types	Aluminum	316 Stainless Steel	Aluminum	Fluoro carbon	0.25 oz. (7.4 ml)	0.75 lbs. (0.34 kgs.)	4.0" (101.6mm)	1.75" (44.5mm)

Flow Rates (SCFM):

Filter Housing Model	Media Grade	100 PSIG	250 PSIG	500 PSIG	750 PSIG	1000 PSIG
A5R/A1R	4	6.4	15	29	43	57
	6	8.4	19	38	56	75
	8	9.2	21	41	61	81
	10	10	23	45	67	88

How to Order:

Example:
A1R-6C04-023

	Port Size NPT			Media Grade	Media Type	Element Size
A	5 (1/8")	R	-	4	G	04-023
	6			6	T	
	8			8	F	
	10			10	H	
					C	

Mounting bracket available: MBS-1

How to Order Replacement Elements:

Elements available: _ insert grade: 4, 6, 8, 10
 _G04-023 X 10
 _T04-023 X 10
 _F04-023 X 10
 _H04-023 X 10
 _C04-023 X 10

For more information on element selection, please see pages 68-69. Elements are sold in Box quantities of 10.

1200 PSIG Pressure Filters

SM-Series

Finite's stainless steel SM-Series housings are perfect for higher-pressure applications in corrosive working environments. Coalescing, particulate and adsorption filters are available. A threaded collar enables the user to easily remove the bowl for servicing, without having to remove the drain fitting and connections. The SM-Series has an SAE-4 drain port with plug.



Critical gas processing applications at elevated pressures rely on the SM-Series to provide clean, contaminant-free gas in corrosive environments.

Specifications:

Model Number	Port Size (NPT)	Max. Pressure	Max. Temp. for each Element Type	Materials of Construction			Seals	Sump Capacity	Weight	Dimensions	
				Head	Internals	Bowl				Length	Width
SMN1S, SMN2S	1/4", 1/2"	1200 PSIG (83 bar)	450°F (T) 350°F (H, G) 275°F (F) 175°F (C, CU, QU, 3PU, AU)	316 Stainless Steel	316 Stainless Steel	316 Stainless Steel	Fluoro carbon	1.8 oz. (53.23 ml)	3.6 lbs. (1.6 kgs.)	5.2" (132 mm)	3.0" (76 mm)
SMN1M, SMN2M	1/4", 1/2"	1200 PSIG (83 bar)	450°F (T) 350°F (H, G) 275°F (F) 175°F (C, CU, QU, 3PU, AU)	316 Stainless Steel	316 Stainless Steel	316 Stainless Steel	Fluoro carbon	1.8 oz. (53.23 ml)	4.7 lbs. (2.1 kgs.)	7.7" (196 mm)	3.0" (76 mm)
SMN1L, SMN2L	1/4", 1/2"	1200 PSIG (83 bar)	450°F (T) 350°F (H, G) 275°F (F) 175°F (C, CU, QU, 3PU, AU)	316 Stainless Steel	316 Stainless Steel	316 Stainless Steel	Fluoro carbon	1.8 oz. (53.23 ml)	5.7 lbs. (2.6 kgs.)	9.7" (246 mm)	3.0" (76 mm)

Flow Rates (SCFM):

Filter Housing Model	Media Grade	100 PSIG	250 PSIG	500 PSIG	750 PSIG	1000 PSIG	1200 PSIG
SMN1S	4	10	23	45	67	88	106
	6	13	30	58	87	115	138
	8	17	39	76	113	150	181
	10	22	51	99	147	195	233
	3PU	22	51	99	147	195	243
	AU	13	30	58	87	115	138
SMN1M	4	20	46	90	133	177	212
	6	26	60	117	173	230	275
	8	34	78	153	227	301	360
	10	44	102	197	293	389	466
	3PU	44	102	197	293	389	466
	AU	26	60	117	173	230	275
SMN1L	4	28	65	126	187	248	296
	6	36	83	162	240	318	382
	8	47	108	211	313	416	498
	10	62	143	278	413	548	657
	3PU	62	143	278	413	548	657
	AU	36	83	162	240	318	382

Filter Housing Model	Media Grade	100 PSIG	250 PSIG	500 PSIG	750 PSIG	1000 PSIG	1200 PSIG
SMN2S	4	16	37	72	107	142	169
	6	22	51	99	147	195	233
	8	29	67	130	193	257	307
	10	37	85	166	247	327	392
	3PU	37	85	166	247	327	392
	AU	22	51	99	147	195	233
SMN2M	4	32	74	144	213	283	339
	6	43	99	193	287	380	456
	8	58	134	260	387	513	615
	10	74	171	332	493	655	784
	3PU	74	171	332	493	655	784
	AU	43	99	193	287	380	456
SMN2L	4	45	104	202	300	398	477
	6	60	138	269	400	531	635
	8	81	187	363	540	717	858
	10	104	240	467	693	920	1102
	3PU	104	240	467	693	920	1102
	AU	60	138	269	400	531	635

Ordering Information:

Series Name	Port Type	Port Size	Bowl	-	Element Grade	Element Type	End Seal	Accessories
SM	N (NPT)	1 (1/4") 2 (1/2")	S (Short) M (Medium) L (Long)		4	C (Coalescer) Q (Coalescer with built-in prefilter) G T F H	Leave blank for no end seal (Available on type G,T,F,H,C) U (Urethane end seals, available on types C,Q,3P,A)	N (No Accessories)
					6			
					8			
					10			
					Leave blank	3P (Pleated Cellulose) Particulate Element		
					Leave Blank	A (Adsorber)		

Examples: SMN2S-8GN
SMN1L-6CUN
SMN2M-3PUN
SMN1M-AUN

Mounting bracket available: MBS-2

How to Order Replacement Elements:

Housing	Element Grade and Type	Element Size
SMN1S, SMN2S	*C, *CU, *QU, *H, *F, *G, *T, 3PU, AU	10-025
SMN1M, SMN2M	*C, *CU, *QU, *H, *F, *G, *T, 3PU, AU	10-050
SMN1L, SMN2L	*C, *CU, *QU, *H, *F, *G, *T, 3PU, AU	10-070

Housings are sold with one element. Build your own replacement element using the steps below. Refer to the chart on the left.

1. Determine the housing you have.
2. Determine the element type and grade you need. *Insert grades 4,6,8 or 10. See pages 68-69 for more detail on grade selection.
3. Determine the corresponding element size.
4. Combine "Element grade and Type" designation with "Element Size" to get part number. For Example: 6QU10-050. Box quantity depends on media type selected.

3600 PSIG Pressure Filters

FFC-112

CNG powered vehicles such as airport shuttles and taxis use FFC-112 filters, which are installed on these vehicles. They protect critical engine components from contaminants present in CNG fuel.



CNG powered engine components such as fuel injectors and pressure reducing valves require contaminant free air. Submicronic solid or lubricant aerosols may carry over during CNG compression. Contaminants can also be generated in the storage and distribution of the natural gas, and may eventually enter the vehicle's storage tank. Both 1/4" NPT and 9/16" SAE connections are available on this 3600 PSIG rated assembly. The machined aluminum housing is anodized to enhance durability. It's robust yet small, lightweight size allows for versatile installation and easy servicing.

Specifications:

Model Number	Port Size	Max. Pressure	Max. Temp.	Materials of Construction			Seals	Sump Capacity	Weight	Dimensions	
				Head	Internals	Bowl				Length	Width
FFC-112	1/4" NPT	3600 PSIG (248 bar)	225°F (107°C)	Anodized Aluminum	Acetal Plastic	Anodized Aluminum	Buna-N	0.5 oz. (14.8 ml)	1.5 lbs. (0.68 kgs.)	4.75" (120.65mm)	2.25" (57.15mm)
FFC-112 SAE	9/16" SAE	3600 PSIG (248 bar)	225°F (107°C)	Anodized Aluminum	Acetal Plastic	Anodized Aluminum	Buna-N	0.5 oz. (14.8 ml)	1.5 lbs. (0.68 kgs.)	4.75" (120.65mm)	2.25" (57.15mm)

Flow Rates (SCFM):

Filter Housing Model	Media Grade	100 PSIG	250 PSIG	500 PSIG	750 PSIG	1000 PSIG	1500 PSIG	2000 PSIG	2500 PSIG	3000 PSIG	3600 PSIG
FFC-112/FFC-112 SAE	6	10	23	45	67	88	132	176	219	263	315
	10	15	35	67	100	133	198	263	329	394	473

How to Order:

How to Order:							Port	Element Grade	
F	F	C	-	1	1	2	Leave blank for NPT	-	6 10
Examples: FFC-112-6 or FFC-112 SAE-10							SAE		

Replacement Elements Available:

Filter Housing Model	Media Grade 6	Media Grade 10
FFC-112/FFC-112 SAE	CLS112-6 X 10	CLS112-10 X 10

Note: X 10 in the part number denotes how many elements are sold in a Box.

Mounting bracket available: MB-2S

FFC-113

Many large CNG powered vehicles, such as buses used in city transit systems rely on FFC-113 filters, which are installed onboard the vehicle itself. They protect critical engine components from contaminants present in alternative fuel gas systems.



The FFC-113 is a popular filter choice onboard alternative fuel vehicles. Tiny solid and liquid contaminants can foul critical engine components, diminishing engine performance. These contaminants are typically generated during the compression, storage, and dispensing of alternative fuel gases like CNG. The FFC-113 removes sub-micronic contaminants with removal efficiencies from 95% to 99.97% ensuring long service intervals for components like fuel injectors.

Its robust 303 stainless steel construction and 3600 PSIG design pressure and relatively light weight combine to provide a unit that will withstand the harsh operating environments found on heavy duty vehicles like buses and trucks. It is supplied with 1/2 NPT connections and is designed for flows exceeding 1550 SCFM at 3600 PSIG.

Specifications:

Model Number	Port Size (NPT)	Max. Pressure	Max. Temp.	Materials of Construction			Seals	Sump Capacity	Weight	Dimensions	
				Head	Internals	Bowl				Length	Width
FFC-113	1/2"	3600 PSIG (248 bar)	175°F (79°C)	303 Stainless Steel	303 Stainless Steel	303 Stainless Steel	Fluoro-carbon	5.0 oz. (147.9 ml)	5.5 lbs. (2.5 kgs.)	8.06" (204.7mm)	2.97" (75.44mm)

Flow Rates (SCFM):

Filter Housing Model	Media Grade	100 PSIG	250 PSIG	500 PSIG	750 PSIG	1000 PSIG	1500 PSIG	2000 PSIG	2500 PSIG	3000 PSIG	3600 PSIG
FFC-113	6	25	58	112	167	221	330	439	548	657	788
	10	50	115	224	333	442	660	878	1096	1314	1576

How to Order:

F	F	C	-	1	1	3	-	Element Grade
Example: FFC-113-6								6 10

Replacement Elements Available:

Filter Housing Model	Media Grade 6	Media Grade 10
FFC-113	DLS113-6 X 6	DLS113-10 X 6

Note: X 6 in the part number denotes how many elements are sold in a Box.

5000 PSIG Pressure Filters

J-Series

J-Series filters are used in a number of applications, ranging from breathing air for scuba divers, to high-pressure hydraulic circuit testing, to a variety of uses in the alternative fuel industry.



Finite's J-Series is designed to filter contaminants such as rust and pipe scale, compressor lube oil, and water from compressed gases. These filters are often used in high pressure compressed natural gas (CNG) systems, not only as inter-stage filters in the multiple stage compression of the gas, but also in the storage and delivery of the gas to CNG powered vehicles.

Finite's varied media choices remove up to 99.995% of both solid and liquid aerosols, and contaminants as small as 0.2 microns in size. Additionally, cartridges are available with either silica gel or molecular sieve, these desiccants adsorb water vapor, drying the high pressure air or gas. An activated carbon media is also available which removes oil vapor. This stage of filtration is often used as the final filter before the storage of high pressure breathing air used by scuba divers, firefighters, and others that utilize portable breathing devices.

The filter housings and the replaceable elements used in this product line have an extremely robust construction, specially designed for use in system pressures up to 5000 psig. Four housing sizes and two thread styles (NPT or SAE) are available with connections ranging from 1/2" to 1 1/2"; temperatures up to 350°F, and flows up to 20,000 SCFM at 5000 PSIG.

Specifications:

Model Number	Port Size	Max. Pressure	Max. Temp. for each Element Type	Materials of Construction			Seals	Sump Capacity	Weight	Dimensions	
				Head	Internals	Bowl				Length	Width
J2SD	SAE-8*	5000 PSIG (345 bar)	350°F (C, 3P, 100WS) 175°F (A)	Ductile Cast Iron	Aluminum	Carbon Steel	Fluoro-carbon	2.0 oz. (60 ml)	9.2 lbs. (4.2 kgs.)	8.1" (205.7 mm)	3.7" (94.0mm)
J2SL	SAE-8*	5000 PSIG (345 bar)	350°F (C, 3P, 100WS) 175°F (A)	Ductile Cast Iron	Aluminum	Carbon Steel	Fluoro-carbon	7.4 oz. (220 ml)	13.1 lbs. (5.9 kgs.)	12.0" (304.8mm)	3.7" (94.0mm)
J4SF/ J4NF	SAE-16/ 1" NPT	5000 PSIG (345 bar)	350°F (C, 3P, 100WS) 175°F (A) 130°F (10J)	Nodular Cast Iron	Aluminum	Nodular Cast Iron	Fluoro-carbon	7.1 oz. (210 ml)	22.1 lbs. (10.0 kgs.)	13.5" (342.9mm)	4.6" (116.8mm)
J6SH/ J6NH	SAE-24/ 1 1/2" NPT	5000 PSIG (345 bar)	350°F (C, 3P, 100WS) 175°F (A) 130°F (10J)	Nodular Cast Iron	Aluminum	Carbon Steel	Fluoro-carbon	21.5 oz. (636 ml)	52.3 lbs. (23.7 kgs.)	21.1" (535.9mm)	6.5" (165.1mm)

How to Order:

Series Name	Port Size	Port Type	Bowl	-	Element Grade	Element Construction	Element Size
J	2 (1/2")	S (SAE-8) Note: 1/2" NPT adapter bushings included.	D (Standard) E (Extra Sump)		4C	WC (metal retainers, bonded on end caps with positive o-ring seal)	11-035 (J2)
					10C		15-070 (J4)
	3P	23-130 (J6)					
					Leave blank	100WS	
	4 (1")	N (NPT) S (SAE-16)	F (Standard)		10J (Available on 1" and 1 1/2" port only)	WM (desiccant dryer with molecular sieve)	
	6 (1 1/2")	N (NPT) S (SAE-24)	H (Standard)			WA (desiccant dryer with activated aluminum)	

Examples: J2SL-10CWC11-035
J4NF-4CWC15-070
J6SH-3PWC23-130

How to Order Replacement Elements:

1. Determine the housing you have by choosing from the "Housing" column on the chart.
2. Determine the "Element Grade and Type" you need. See pages 68-69 for more detail on grade selection.
3. Determine the corresponding element size by choosing from the "Element Size" column on the chart.
4. Combine "Element Grade and Type", "Element Size" and "Box Quantity" get part number.

Example: 4CWC15-070 X 2 or 3PWC23-130 X 1

Housings are sold with one element. Build your own replacement element with the chart below.

Housing	Element Grade and Type	Element Size	X	Box Quantity
J2SD, J2SL	4CWC, 10CWC, 3PWC, AWC, 100WS	11-035		4
J4NF, J4SF	4CWC, 10CWC, 3PWC, AWC, 100WS, 10JWM, 10JWA	15-070		2
J6NH, J6SH	4CWC, 10CWC, 3PWC, AWC, 100WS, 10JWM, 10JWA	23-130		1

High Pressure & CNG Filters

Use a high pressure drain kit with Finite's J-Series... see page 88!



For J-Series Flow Rates ... see next page!

J-Series (5000 PSIG) Flow Rates (SCFM):

Filter Housing Model	Media Grade	100 PSIG	1000 PSIG	1500 PSIG	2000 PSIG	2500 PSIG	3000 PSIG	3500 PSIG	4000 PSIG	4500 PSIG	5000 PSIG
J2SD/J2SL	4C	30	265	400	527	658	800	919	1050	1200	1333
	10C	60	531	800	1054	1315	1600	1839	2100	2400	2667
	3P	60	531	800	1054	1315	1600	1839	2100	2400	2667
	A	30	265	400	527	658	800	919	1050	1200	1333
	100WS	60	531	800	1054	1315	1600	1839	2100	2400	2667
J4SF/J4NF	4C	75	663	1000	1317	1644	2000	2298	2625	3000	3333
	10C	150	1327	2000	2635	3289	4000	4596	5250	6000	6667
	3P	150	1327	2000	2635	3289	4000	4596	5250	6000	6667
	A	75	663	1000	1317	1644	2000	2298	2625	3000	3333
	100WS	150	1327	2000	2635	3289	4000	4596	5250	6000	6667
	10JWM	150	1327	2000	2635	3289	4000	4596	5250	6000	6667
	10JWA	150	1327	2000	2635	3289	4000	4596	5250	6000	6667
J6SH/J6NH	4C	225	1990	3000	3952	4933	6000	6895	7875	9000	10000
	10C	450	3981	6000	7904	9866	12000	13789	15751	18000	20000
	3P	450	3981	6000	7904	9866	12000	13789	15751	18000	20000
	A	225	1990	3000	3952	4933	6000	6895	7875	9000	10000
	100WS	450	3981	6000	7904	9866	6000	13789	15751	6000	6667
	10JWM	450	3981	6000	7904	9866	6000	13789	15751	6000	6667
	10JWA	450	3981	6000	7904	9866	6000	13789	15751	6000	6667

High Pressure
& CNG Filters



Scuba divers rely on clean, dry air to fill their air tanks. Finite filters ensure that any impurities, such as oil, water or particulate are removed before entering the tanks.

FFC-116

Many CNG powered commuter vehicles, such as shuttle buses, taxis or vans, rely on FFC-116 filters to protect contaminants from fouling fuel injector systems. Both solid and liquid contaminants can enter the system from various sources.



This stainless steel filter is commonly used to filter oil, water and particulate from lower flow CNG systems and onboard CNG vehicles. Its small size allows for installation versatility and ease of servicing. The 316 stainless steel construction resists corrosion. Its 5000 PSI design enables it to be used on the high pressure side of a CNG system, protecting both the regulator and the fuel injectors. The sump capacity is 0.25 oz. (7.4 cc) for fluid contaminants, which can be drained through a plugged 1/4" NPT drain port.

Specifications:

Model Number	Port Size (NPT)	Max. Pressure	Max. Temp.	Materials of Construction			Seals	Sump Capacity	Weight	Dimensions	
				Head	Internals	Bowl				Length	Width
FFC-116	1/4"	5000 PSIG (345 bar)	350°F (177°C)	316 Stainless Steel	316 Stainless Steel	316 Stainless Steel	Fluoro carbon	0.25 oz. (7.4 ml)	1.16 lbs. (0.53 kgs.)	4.0" (101.6mm)	1.75" (44.5mm)

Flow Rates (SCFM):

Filter Housing Model	Media Grade	100 PSIG	1000 PSIG	1500 PSIG	2000 PSIG	2500 PSIG	3000 PSIG	3500 PSIG	4000 PSIG	4500 PSIG	5000 PSIG
FFC-116	6	8.4	74	111	148	184	221	257	294	331	368
	10	10	90	132	176	219	263	306	350	394	438

How to Order:

How to Order:								Element Grade
F	F	C	-	1	1	6	-	6 10

Example: FFC-116-6

Replacement Elements Available:

Filter Housing Model	Media Grade 6	Media Grade 10
FFC-116	CLS116-6 X 10	CLS116-10 X 10

Note: X 10 in the part number denotes how many elements are sold in a box.

Mounting bracket available: MBS-1

6000 PSIG Pressure Filters

SJ-Series



This robust, stainless steel filter is rated for working pressures up to 6000 PSIG, which makes this the filter of choice for extremely demanding applications. The SJ-series comes in a variety of port sizes and types, reducing the need for extra piping or the use of adapters in your application. The 1/4" drain port allows the user to drain all oil from the assembly prior to servicing, eliminating possible cross contamination and leaving a cleaner environment. Use this filter for your offshore applications, water fogging, caustic washdowns (food processing) or on high pressure test stands. A wide variety of filter element media grades and styles means that your application needs will be efficiently met.

Specifications:

Model Number	Port Size (NPT or SAE)	Max. Pressure	Max. Temp. for each Element Type	Materials of Construction			Seals	Sump Capacity	Weight	Dimensions		Replacement Element Size
				Head	Internals	Bowl				Length	Width	
SJN*S, SJS*S	1/2"-1"	6000 PSIG (414 bar)	175°F (Grade A) 350°F (All other grades)	316L Stainless Steel	316L Stainless Steel	316L Stainless Steel	Fluoro-carbon	2.1 oz. (61 ml)	14 lbs. (6.4 kgs.)	8.26" (210mm)	4.00" (102mm)	11-036
SJN*L, SJS*L	1/2"-1"	6000 PSIG (414 bar)	175°F (Grade A) 350°F (All other grades)	316L Stainless Steel	316L Stainless Steel	316L Stainless Steel	Fluoro-carbon	7.8 oz. (230 ml)	18 lbs. (8.2 kgs.)	11.97" (304mm)	4.00" (102mm)	11-036
SJN*H, SJS*H	1/2"-1"	6000 PSIG (414 bar)	175°F (Grade A) 350°F (All other grades)	316L Stainless Steel	316L Stainless Steel	316L Stainless Steel	Fluoro-carbon	2.1 oz. (61 ml)	17 lbs. (7.7 kgs.)	11.97" (304mm)	4.00" (102mm)	11-072

*insert port size: 2 = 1/2", 3 = 3/4" and 4 = 1"

How to Order:

Series Name	Port Type	Port Size	Bowl	Element Grade	Element Construction	Accessories
SJ	N (NPT) S (SAE)	2 (1/2")	S (Standard)	-	4C	N (No Accessories)
		3 (3/4")			10C	
		4 (1")	3P			
			L (Long bowl, short element, extra sump)	A	WC (metal retainers, bonded on end caps with positive o-ring seal.)	Examples: SJN2S-4WCN SJS3L-3PWCN
		H (High Flow: Long bowl, long element)	100WS	Leave blank		

How to Order Replacement Elements:

Housings are sold with one element. Build your own replacement element with the chart below.

Housing	Element Grade and Type	Element Size
SJN*S, SJS*S, SJN*L, SJS*L	4CWC, 10CWC, 3PWC, AWC, 100WS	11-036
SJN*H, SJS*H	4CWC, 10CWC, 3PWC, AWC, 100WS	11-072

1. Determine the housing you have by choosing from the "Housing" column on the chart. *Insert port size. See How to Order above for more info on port sizes.
2. Determine the "Element Grade and Type" you need. See pages 68-69 for more detail on grade selection.
3. Determine the corresponding element size by choosing from the "Element Size" column on the chart.
4. Combine "Element Grade and Type", "Element Size" and then add Box quantity to the end. Box quantities are all X 4, except 100WS which is X 1. Example: 4CWC11-036 X 4 or 100WS11-072 X 1.



Use a high pressure drain kit with Finite's SJ-Series... see page 104!

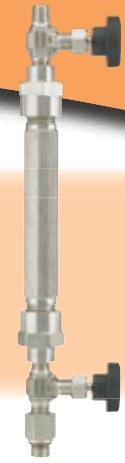

Flow Rates (SCFM):

Filter Housing Model	Media Grade	100 PSIG	250 PSIG	500 PSIG	750 PSIG	1000 PSIG	1500 PSIG	2000 PSIG	2500 PSIG	3000 PSIG	3500 PSIG	4500 PSIG	5000 PSIG	5500 PSIG	6000 PSIG
SJN_S	4C	25	58	112	167	221	330	439	548	657	766	984	1093	1202	1311
	10C	55	127	247	367	487	726	966	1206	1446	1685	2165	2405	2644	2884
	3P	55	127	247	367	487	726	966	1206	1446	1685	2165	2405	2644	2884
	A	33	76	148	220	292	436	580	723	867	1011	1299	1443	1587	1731
	100	55	127	247	367	487	726	966	1206	1446	1685	2165	2405	2644	2884
SJS_S	4C	25	58	112	167	221	330	439	548	657	766	984	1093	1202	1311
	10C	55	127	247	367	487	726	966	1206	1446	1685	2165	2405	2644	2884
	3P	55	127	247	367	487	726	966	1206	1446	1685	2165	2405	2644	2884
	A	33	76	148	220	292	436	580	723	867	1011	1299	1443	1587	1731
	100	55	127	247	367	487	726	966	1206	1446	1685	2165	2405	2644	2884
SJN_L	4C	25	58	112	167	221	330	439	548	657	766	984	1093	1202	1311
	10C	55	127	247	367	487	726	966	1206	1446	1685	2165	2405	2644	2884
	3P	55	127	247	367	487	726	966	1206	1446	1685	2165	2405	2644	2884
	A	33	76	148	220	292	436	580	723	867	1011	1299	1443	1587	1731
	100	55	127	247	367	487	726	966	1206	1446	1685	2165	2405	2644	2884
SJS_L	4C	25	58	112	167	221	330	439	548	657	766	984	1093	1202	1311
	10C	55	127	247	367	487	726	966	1206	1446	1685	2165	2405	2644	2884
	3P	55	127	247	367	487	726	966	1206	1446	1685	2165	2405	2644	2884
	A	33	76	148	220	292	436	580	723	867	1011	1299	1443	1587	1731
	100	55	127	247	367	487	726	966	1206	1446	1685	2165	2405	2644	2884
SJN_H	4C	62	143	278	413	548	819	1089	1359	1630	1900	2440	2711	2981	3252
	10C	136	314	610	907	1203	1796	2389	2982	3575	4167	5353	5946	6539	7133
	3P	136	314	610	907	1203	1796	2389	2982	3575	4167	5353	5946	6539	7133
	A	82	189	368	547	725	1083	1440	1798	2155	2513	3228	3585	3943	4301
	100	136	314	610	907	1203	1796	2389	2982	3575	4167	5353	5946	6539	7133
SJS_H	4C	62	143	278	413	548	819	1089	1359	1630	1900	2440	2711	2981	3252
	10C	136	314	610	907	1203	1796	2389	2982	3575	4167	5353	5946	6539	7133
	3P	136	314	610	907	1203	1796	2389	2982	3575	4167	5353	5946	6539	7133
	A	82	189	368	547	725	1083	1440	1798	2155	2513	3228	3585	3943	4301
	100	136	314	610	907	1203	1796	2389	2982	3575	4167	5353	5946	6539	7133

High Pressure Drain Kits

Product Overview

High pressure compressed gas systems oftentimes contain excessive amounts of liquid aerosols. This liquid can best be removed by utilizing Finite's J-Series or SJ-Series coalescing filters. A Grade 10 filter followed by a Grade 4 filter will remove greater than 99.995% of the liquid water and/or oil carryover from the compressed gas system. This liquid can now be safely removed with Finite's NEW High Pressure Drains (JDK and SJDK Series)! These drains are fully-assembled and are constructed of 316 Stainless Steel. They include two needle valves, fittings, and a pipe reservoir.

The JDK Series is rated for 5000 PSIG and connects directly to the bottom of the J-Series filter housings. The SJDK Series is rated for 6000 PSIG and connects directly to the bottom of the SJ-Series housing. These High Pressure Drains are offered in both vertical and horizontal orientations. The vertical orientation is ideal for applications in which there is adequate bowl removal clearance, while the horizontal orientation is ideal for applications with limited bowl removal clearance.

Operation

Finite's new High Pressure Drains allow the user to safely remove condensate from a high pressure compressed gas system. Proper operation of the drain involves keeping the first needle valve open and the second needle valve closed. The liquid that is coalesced from the filter will empty into the drain's high pressure reservoir and fill the internal volume with liquid.

When it is time to expel the liquid from the drain kit (usually on a preventative maintenance schedule), the top needle valve should be closed to shut off system pressure. The bottom needle valve should then be opened SLOWLY since the liquid will discharge rapidly from the drain. This procedure should be repeated until all of the liquid has been removed from the filter bowl and drain reservoir.

All liquid should be collected and disposed of in accordance with local regulations.

JDK5000V/
SJDK6000V



JDK5000H/
SJDK6000H

A direct connection

Finite's drain kits can be used in many high pressure air or gas system. They can also be used to hook up directly to Finite's J-Series (pages 98-100) or Finite's SJ-Series (pages 102-103).



Finite's J-Series

Finite's SJ-Series

Part Number	Description	Inlet	Outlet	Max Pressure	Max Temp.
JDK5000V	Vertical J-Series Drain	SAE-6	1/4" NPT	5000 PSIG (345 bar)	100°F (38°C)
JDK5000H	Horizontal J-Series Drain	SAE-6	1/4" NPT	5000 PSIG (345 bar)	100°F (38°C)
SJDK6000V	Vertical SJ-Series Drain	SAE-4*	1/4" NPT	6000 PSIG (414 bar)	100°F (38°C)
SJDK6000H	Horizontal SJ-Series Drain	SAE-4*	1/4" NPT	6000 PSIG (414 bar)	100°F (38°C)

*The SAE-4 fitting can be removed to adapt to 1/4" NPT.

ADS-50
304 Stainless Steel
Automatic Drain Trap



Specifications:

Max Temperature:	450°F (232°C)
Max Pressure:	250 PSIG (17 bar)
Connections:	1/2" NPT inlet and outlet

TD-50
Adjustable Timed Drain Valve



Specifications:

Max Temperature:	150°F (66°C)
Max Pressure:	600 PSIG (42 bar)
Connections:	1/2" NPT inlet and outlet

TV-25-700
Timed Drain Valve



Specifications:

Max. Temperature:	210°F (99°C)
Max. Pressure:	700 PSIG (48 bar)
Connections:	1/4" NPT

DPI-25
Differential Pressure Gauge



Specifications:

Max. Temperature:	200°F (88°C)
Max. Pressure:	5000 PSIG (340 bar)
Connections:	1/4" NPT

Other options available:

- BDPI-25 (DPI-25 with mounting brackets)
- DPS-25 (DPI-25 with SPST reed switch included)
- BDPS-25 (DPS-25 with mounting brackets)

DPG-15HP
Differential Pressure
Gauge



Specifications:

Max. Temperature:	200°F (93°C)
Max. Pressure:	800 PSIG (55 bar)
Connections:	Holes on M-Series housing must be predrilled

Notes

Price List Notes

1. Prices shown are ex-works Melbourne and are subject to change without notice. Express deliveries can be arranged if required. Please contact Parker domnick hunter for further details. Prices are in AUD and do not include GST.
2. All carbon steel fabricated pressure vessels are designed and manufactured in accordance with the European Pressure Vessel Standard (CEN) EN286 part 1 (1991), with ND16 BS4504 16/3 flanges, or to AS1210 or Table E standards.
3. Other flange options are available at extra cost; please specify:-
ANSI CLS 150 RFSO
DIN 2633 RFWN
ANSI CLS 150 RFWN
4. Hydraulic pressure Test Certificates can be supplied on request, for fabricated vessels.
5. Non destructive testing of vessels will be charged at extra cost.
6. Vessel design calculations, if requested, will be charged at extra cost.
7. Material test certificates, special inspections and hydraulic pressure test certificates for die-cast vessels can be supplied if requested at the time of placing orders and will be charged at extra cost.
8. Product lead times are given for general information and guidance only. Many factors can influence lead times which will be quoted specifically upon request. No warranty is given or implied.
9. Parker Hannifin Conditions of Sale apply to all business transactions and will be strictly in accordance with details printed on our order acceptance and invoice.
10. Parker Hannifin limited has an on-going policy of product development and although the Company reserves the right to change specifications it attempts to keep customers informed of any alterations. This publication is for information only and customers are requested to ask our Sales Department for advice on a product's suitability for specific applications.

National Filtration Customer Service & Order Entry

Sydney

9 Carrington Road
CASTLE HILL NSW 2154
Ph 02 9842 5110
Fax 02 9842 5111

Parker Regional Sales Offices

Adelaide

Cnr Roseberg & Lafitte Rds
WINGFIELD SA 5013
Ph 08 8168 4300
Fax 08 8168 4399

Brisbane

4/68 Murdoch Circuit
ACACIA RIDGE QLD 4110
Ph 07 3272 8244
Fax 07 3272 6699

Mackay

45-47 John Vella Drive
PAGET QLD 4740
Ph 07 4952 4890
Fax 07 4952 4895

Melbourne

305 Frankston Road
DANDENONG VIC 3175
Ph 03 9768 5555
Fax 03 9768 5556

Newcastle

Unit 5/6, Lot 3 Kullara Avenue
BERESFIELD NSW 2322
Ph 02 4964 2198
Fax 02 4964 2280

Perth

10 Hodgson Way
KEWDALE WA 6105
Ph 08 9353 4011
Fax 08 9353 4088

Townsville

7 Bain Street
CURRAJONG QLD 4812
Ph 07 4725 5187
Fax 07 4725 5513

New Zealand

2 Timaru Place
MT WELLINGTON, AUCKLAND
Ph +64 9574 1744
Fax +64 9573 1529

